



# VM2 USER MANUAL



# CONTENTS

1	Quick Start Guide . . . . .	6
1.1	Changing The Programming Options . . . . .	6
1.1.1	Virtual Keypad . . . . .	6
1.1.2	4-line Keypad . . . . .	7
1.2	Jumpers . . . . .	10
1.3	VM2 Fence Layouts. . . . .	11
1.4	Most Frequently Used LCD Keypad Commands . . . . .	12
2	Introduction . . . . .	13
3	Features And Benefits . . . . .	14
3.1	More Features . . . . .	15
4	Description . . . . .	16
4.1	JVA VM2 - Exterior . . . . .	16
4.2	Front Panel Status Lights . . . . .	17
4.3	Front Panel LCD Display . . . . .	17
4.4	Z-Series Keypad (Optional) . . . . .	18
4.5	Internal Beeper . . . . .	18
4.6	Arm / Disarm . . . . .	18
4.7	Cabling . . . . .	19
4.8	Lightning Protection . . . . .	20
4.9	Noise and Interference. . . . .	20
5	Installation. . . . .	22
5.1	Installation Steps . . . . .	22
5.2	Sensor Wiring. . . . .	24
5.3	24Vdc connection. . . . .	25
5.4	Strobe and Siren Connection . . . . .	25
5.5	4-Line Keypad . . . . .	26
5.6	Example Group Wiring . . . . .	27

6	Cable Handling . . . . .	28
6.1	Cable care . . . . .	28
6.2	Joining and terminating the cable . . . . .	28
6.3	Method for burying cable . . . . .	28
6.4	Websites with useful information . . . . .	29
6.5	Method for attaching to fence. . . . .	29
7	Tuning . . . . .	30
7.1	Test Mode . . . . .	30
8	Control . . . . .	33
8.1	Arming the Fence Using the Keypad. . . . .	33
8.2	When an Alarm Occurs. . . . .	33
8.3	To Silence the Alarm . . . . .	33
8.4	Changing the USER PIN. . . . .	34
9	Technical Information. . . . .	35
9.1	Power Options . . . . .	36
9.2	Standby Battery. . . . .	36
9.3	Status Codes . . . . .	37
9.4	Jumpers . . . . .	38
10	Programming Options . . . . .	40
10.1	Changing the Installer PIN . . . . .	40
10.2	Programming Mode . . . . .	40
10.3	Programming Options . . . . .	40
10.3.1	Group ID . . . . .	40
10.3.2	Zone Threshold (1 and 2).. . . . .	40
10.3.3	Zone Events (1 and 2) . . . . .	41
10.3.4	Zone Window (1 and 2). . . . .	41
10.3.5	Sample Time . . . . .	42
10.3.6	Dynamic Noise Rejection (DNR) . . . . .	42
10.3.7	Battery Float . . . . .	42

10.3.8	Battery Alarm . . . . .	43
10.3.9	Gate Delay . . . . .	43
10.3.10	Siren On Time . . . . .	43
10.3.11	Siren Off Time . . . . .	43
10.3.12	Siren Cycles . . . . .	43
10.3.13	Auto Rearm . . . . .	44
10.3.14	Gate Alarm Time. . . . .	44
10.3.15	Chime Mode (Option 14) . . . . .	44
10.3.16	Input Function . . . . .	45
10.3.17	Input Type . . . . .	45
10.3.18	Output/Relay Function . . . . .	46
11	VM2 Specifications . . . . .	48
12	Z-Series Keypads . . . . .	49
12.1	PTE0240 4-line Keypad. . . . .	49
12.2	PTE0230 Touch Keypad. . . . .	50
12.3	Connecting Multiple Keypads . . . . .	51
12.4	Keypad Configuration Notes. . . . .	51
12.5	4-Line Keypad Commands . . . . .	52



# 1 QUICK START GUIDE

## 1.1 CHANGING THE PROGRAMMING OPTIONS

Default Installer PIN	012345
Default User PIN	1234
Default Wi-Fi Password	jvasecure

There are two options for changing programming options. Using the Virtual Keypad or a 4-line Keypad.

### 1.1.1 Virtual Keypad

You can connect any Wi-Fi enabled device to the VM2 (laptop or smart phone) and use a Web browser (Chrome is preferred) on this device to change the programming options.

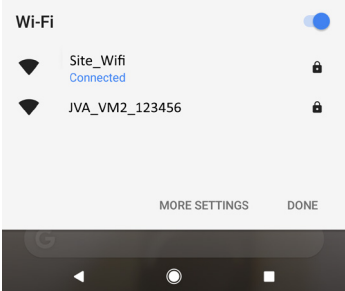
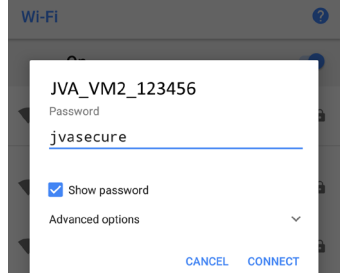
<p>First you need to connect to the VM2 Wi-Fi module. The SSID of the VM2 is JVA_VM2_XXX where XXX is the Serial Number of the unit.</p>	
<p>Enter the Wi-Fi password.</p>	

Open your browser. In the Search bar, type 192.168.4.1 and press Enter. You may have to turn off your mobile data to force the device to use the VM2 Wi-Fi. Re-load the page (Pull the screen down) after the first time it loads to ensure all files are correctly loaded by your device.

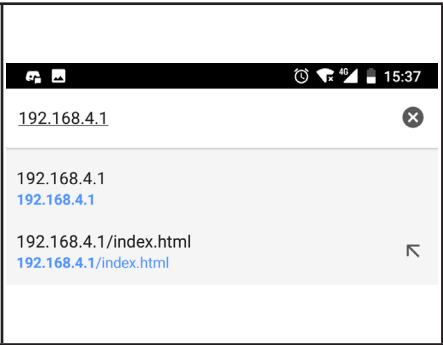

At the bottom of the page is Device Setup. Click on this and enter the Installer PIN. The screen will change to display the programming options. Now click on the option to change and select the new value. When finished, press the Save button.

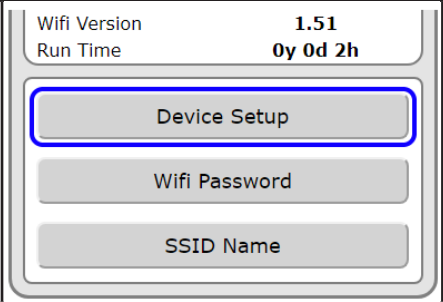

**1.1.2 4-line Keypad**

Enter Programming mode by pressing the three horizontal lines. When the “Enter PIN” message is seen, type in the Installer PIN and press #.

Command	Key 1	2	3	4	5	6	7	8	
Open the Menu	≡	Installer PIN							#
Scroll down the Menu	8								
Scroll up the Menu	2								
Select the Menu Option	#								

When the Menu opens, scroll down to the “Device Programming” menu. Press # to select this. The programming system will start to operate. Select the VM2 from the list. The programming options will be read from the VM2 and displayed in a menu system. Use the up/down arrow keys to move between the options. Use the left/right arrow keys to change options. When finished press # to save.

Press the Menu key to exit programming.

### 1.1.3 Programming Options

Option	Description
Group ID	A group of connected device must have unique IDs. Default 1.
Zone Threshold	Sets a limit above which a sound is considered an Event worth counting. Default 25%
Zone Events	The number of times a sound must exceed the threshold, within the Window time, to cause an alarm. Default 5.
Zone Window	A moving window of time over which Events are counted to see if they exceed the Events setting. Default 3.0 seconds
Sample Time	The noise must remain above this sample time to be counted as an event.
Zone DNR/Squelch	Dynamic Noise Reduction (Squelch) reduces the effect of any constant noise i.e. 50Hz. Default Off.
Battery Float	Battery float setting at 25C. The VM2 will charge to 1V higher on a boost cycle after a mains fail event, once per 8hrs at most. Default 13.7V
Battery Alarm	Low battery level below which a low battery event is triggered. Default 11.0V
Siren On/Off/Cycle Time	When an Alarm triggers, the Siren output will turn On (siren sounding), Off (quiet) and this will repeat based on the Cycle Number. Default On: 180 seconds; Off: 5 minutes; Cycle: 3
Auto Rearm	The time which must elapse before another alarm will sound after the first alarm has timed out. Default 0 (Immediate rearm).
Gate Alarm	The time the Gate input must remain open before the Gate Alarm will trigger. Default 180 seconds.
Input 1	The function and hardware type for Input 1. Default N/O Arm Zone 1.
Input 2	The function and hardware type for Input 2. Default N/O Arm Zone 2.
Output 1	The function for Output 1. Default Strobe Zone 1.



Option	Description
Output 2	The function for Output 1. Default Strobe Zone 2.
Output 3	The function for Output 1. Default Siren.
Output 4	The function for Output 1. Default Zone 1 or Zone 2 Armed.
Output 5	The function for Output 1. Default Zone 1 or Zone 2 Alarm.
Output 6	The function for Output 1. Default General Alarm.

## 1.2 JUMPERS

Jumpers quickly allow you to turn on and off different features, or reset the device to defaults.

JUMPER	FUNCTION
J3	Enable Electric Fence Noise Synchronisation for non-JVA energizers.
J4	Factory default jumper Off to return programmable options to factory defaults on power up.
J6, J7 & J8	Supplies +12V to the Common terminal of Relay 4, 5, 6.

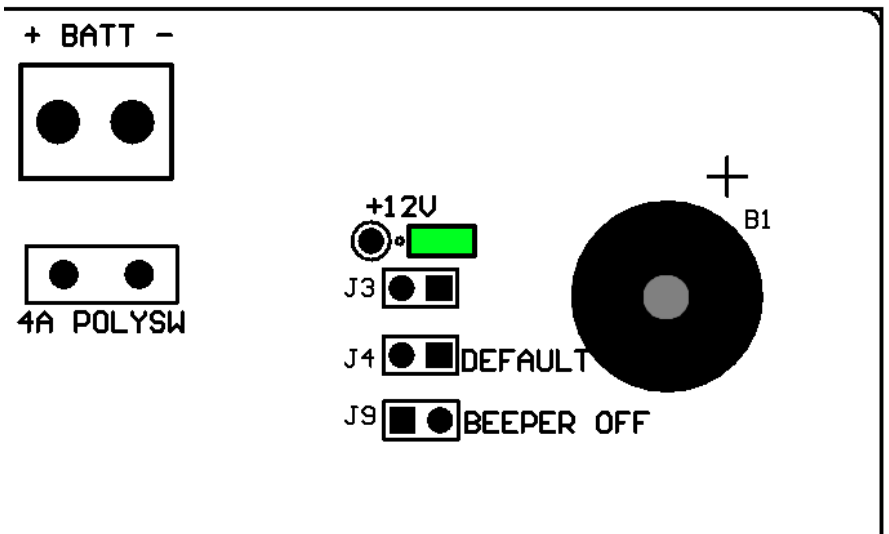

*Jumpers located on the top right hand side of the board*

# 1.3 VM2 FENCE LAYOUTS

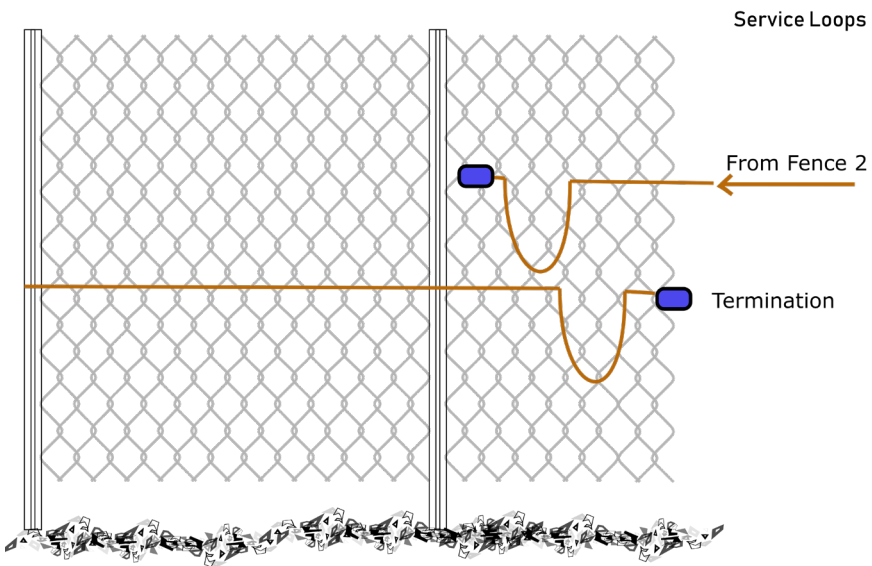
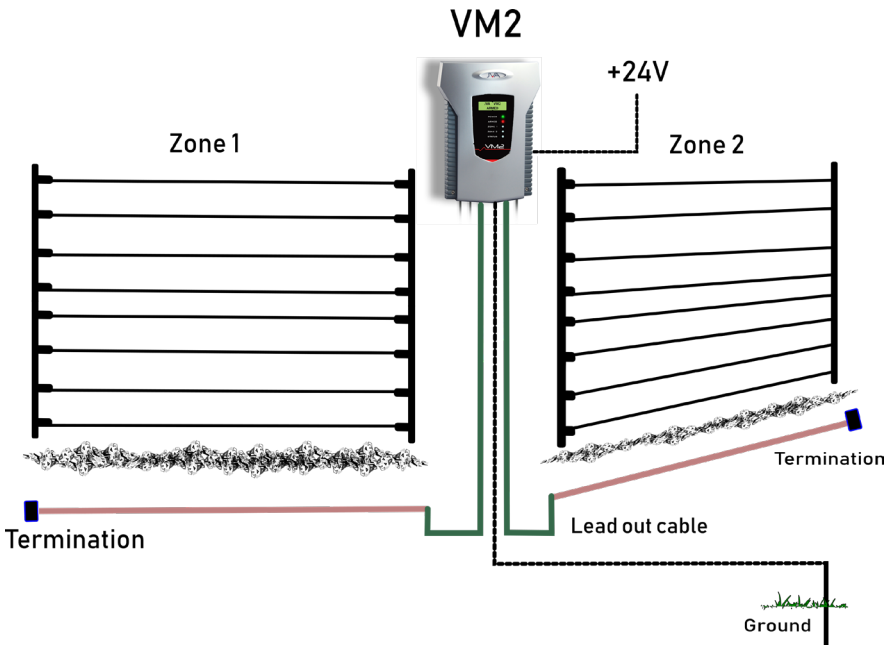



## 1.4 MOST FREQUENTLY USED LCD KEYPAD COMMANDS

For a full list of all keypad commands please see “12.5 4-Line Keypad Commands” on page 52.

Default User PIN	1234
------------------	------

First you need to connect the Z-Series LCD keypad to the Z-Series device. Once you have a keypad connected you can refer to the table below to control the Z-Series device.

Command	Key1	Key2	Key3	Key4	Key5	Key6	Key7	Key8	Key9
Arm/Disarm	User PIN								
Silence alarm	1	4	7	0	#				
Arm All Zones		User PIN							
Arm Specific Zone (up to Zone 15)	User PIN				*	1	Zone Number		#
Disarm all Zones		User PIN							
Disarm Specific Zone (up to Zone 15)	User PIN				*	2	Zone Number		#
Clear alarm memory	*	1	#						

## 2 INTRODUCTION

---

The JVA Vibration Monitor (VM2) is a Perimeter Intrusion Detection System utilising Microphonic Cable. The VM2 (PTE0342) is designed to monitor one or two zones of Microphonic (acoustic) cable to enable the detection of a breach of a perimeter by detection of noise and vibrations created by unauthorised access or vandalism. The monitored cables may be buried to detect digging, attached to a fence or placed inside a wall, roof or floor etc. to detect illegal activity. The VM2, coupled with correctly installed cable creates a fully monitored, zoned intrusion detection system.

The VM2 has adjustable threshold and time parameters to allow the installer to tune the system to differentiate between an intrusion attempt and normal environmental sounds or vibrations. The VM2 complements JVA's range of security electric fence energisers and monitors. The VM2 is also compatible with the JVA Z-Series accessories and software solutions. The VM2 comes with an inbuilt Wi-Fi Webserver which creates a professional Virtual Keypad™ for setup and control. As well as providing the features of a wired keypad, the Virtual Keypad™ is equivalent to both a user and an installer App, however it does not require any App to be downloaded.

This unit can operate as a stand-alone alarm system through the addition of a Siren and Strobe; however the addition of one of the optional user Interfaces makes the system more user friendly. These options include a 4-Line Keypad, Touch Keypad, Perimeter Patrol and the Cloud Router application.

There are a variety of system integration options ranging from low level IO to a HLI based on JVA's Perimeter Patrol software.

Feature	Benefits
Australian designed and manufactured	High reliability and great service
Low priced	Low priced
Electric Fence Compatible	Can be used with Security Electric Fencing (adjacent to, or on the same fence)
JVA Integration	Monitor and Control using: Z Series Keypads Perimeter Patrol Cloud Router Virtual Keypad (VKP)
Two Zone Detection	Able to monitor two runs of up to 300m of active cable
Flexibile Security Implementation	Buried cable sensor system Detects digging with any reasonable tool, shovel, pick, crowbar etc.  Coupled (secured) to palisade or mesh fencing Detects cutting by a power tool Detects hammering or crowbar bending bars apart
Independent settings for each zone	Lower false alarms
On board Wi-Fi	Virtual Keypad Programming speeds up configuration
Self Diagnostics	On board LEDs for quick self-test.

### 3.1 MORE FEATURES

- Built in charger and space for a 12V 7.2aH backup battery.
- Alarms on noise, cut cable, shorted cable.
- Monitor via PC (using Perimeter Patrol software).
- Internal beeper.
- AC fail, low battery and bad battery detection.
- Large number of programmable options.
- Adjustable detection systems per zone.
- Three 12V dc switch outputs (also referred to as relays).
- Three voltage free relays.
- Two control Inputs configured as N/O, N/C, momentary contacts.
- Input and Output functions are individually programmable.

## 4

## DESCRIPTION

---

### 4.1

### JVA VM2 - EXTERIOR





## 4.2 FRONT PANEL STATUS LIGHTS

Status Light	Description
POWER	On (Green) whenever the unit has power
ARMED	On (Red) when the unit is armed (pulsing), will flash when only 1 zone is armed
ZONE 1	On (Red) when zone 1 is in alarm
ZONE 2	On (Red) when zone 2 is in alarm
STATUS	The number of times the status/fault light flashes indicates any faults on the VM2. The Virtual Keypad will provide more information on the fault.

## 4.3 FRONT PANEL LCD DISPLAY

The display on the JVA VM2 shows the fence conditions for each zone.



The image shows four panels of the JVA VM2 LCD display arranged in a 2x2 grid. Each panel has a dark green background with white text. The top-left panel displays 'JVA VM2' and 'ARMED'. The top-right panel displays 'ZONE 1 PEAK 2%' and 'AVG 3% EV'S 0'. The bottom-left panel displays 'Alarm: Zone 1' and 'Noise'. The bottom-right panel displays 'Trouble' and 'Batt Flat'.

JVA VM2 ARMED	ZONE 1 PEAK 2% AVG 3% EV'S 0
Alarm: Zone 1 Noise	Trouble Batt Flat

PEAK: peak noise recorded in the last window of time.

AVG: the average noise level.

EV'S: the events counted in the last window of time.

When an alarm occurs the screen will detail the type of alarm.

Various "Troubles" are also displayed, such as low battery or 24V supply

## 4.4 Z-SERIES KEYPAD (OPTIONAL)

A Z-Series keypad allows for easy remote control of your JVA VM2. Arming and disarming, responding to alarms or just checking the fence situation, the keypad makes this easy through a simple menu system or key sequences (shortcuts). Your security is protected by a user PIN.

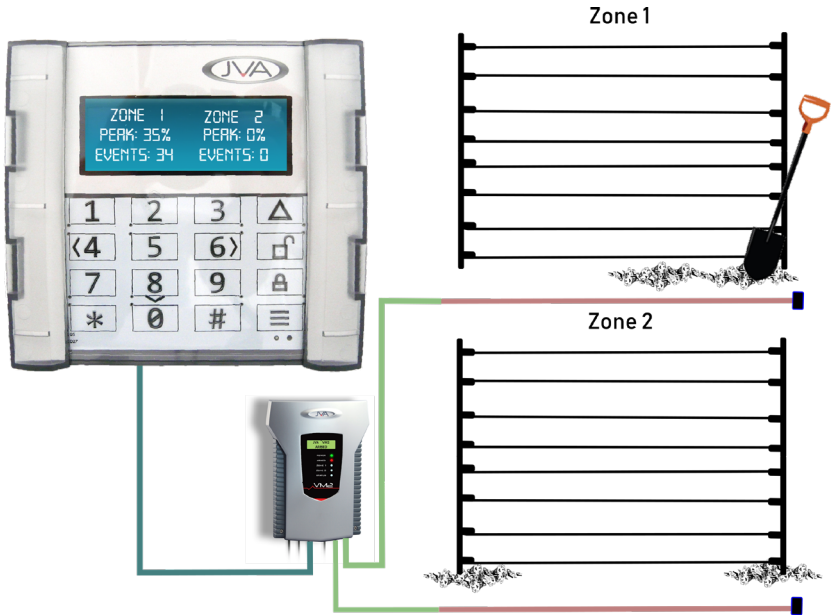

## 4.5 INTERNAL BEEPER

Depending on the chime setting, the internal beeper will sound when there is a fence alarm, a gate alarm, a door chime or a general alarm.

The beeper can be bypassed manually by fitting the black jumper across both of the Disable Beeper pins.

## 4.6 ARM / DISARM

The Virtual Keypad can be used to Arm/Disarm the VM2 when within Wi-Fi range of the unit. The control inputs can also be used by creating a connection between IN1 (or IN2) and the common (Com) pin. Alternatively a keypad, RF remote control or one of the JVA software solutions can be used to remotely control the VM2.

## 4.7 CABLING

RG58 wire should be used as the lead-out cable to the zone to be monitored. This ensures the lead-out cable is not part of the detection cable and therefore isolates a potential false alarm source. The detection cable should be joined to the lead-out at a suitable location near the detection zone.

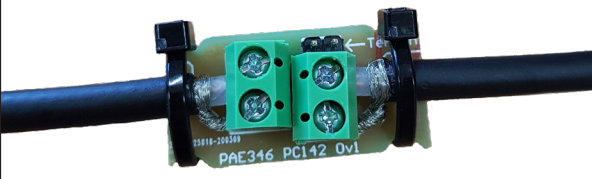
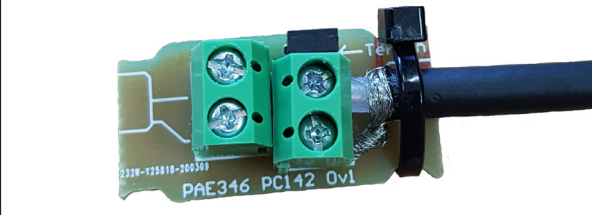
Detection cable has a loose centre wire enabling noise detection	
Use a PAE346 circuit board to connect the RG58 and detection cable. Remove the Jumper from the pins.	
The end of the detection cable needs to be terminated using the same PAE346 board. Ensure the Jumper is fitted on the two pins	

The wires connecting to the PAE346 board should be secured using cable ties before being enclosed in a weather proof junction box (MHC017) to protect it from the weather and insects.

Electric fence high voltage cables must never be run within the same conduit as low voltage cables. A minimum distance of 30mm should be kept between high voltage and low voltages cables.

To maintain the IPx4 rating of the enclosure and to ensure moisture does not enter the enclosure via the cable entry area a silicon sealant (neutral cure) must be used to seal all the cable passages.

## 4.8 LIGHTNING PROTECTION

The VM2 contains basic lightning protection elements, as such external lightning protection kits are recommended to further reduce lightning damage and thus reduce repair costs. They are available from your local dealer.

## 4.9 NOISE AND INTERFERENCE

The VM2 contains a microprocessor. Extreme electrical noise can upset microprocessors. The most likely cause of such noise is a high voltage output from an Electric Fence Energizer. In the event of erratic behaviour, check that any high voltage wiring is not arcing nearby the VM2. The VM2 is designed to self-recover from interference. Powering off (both 24V dc and battery) should not be necessary.



## 5 INSTALLATION

It is recommended that all installations are performed by trained personnel. Training is available from JVA.

### 5.1 INSTALLATION STEPS

1. Read the entire manual first.
2. Install the WR043 sensor cable.
3. Join the sensor cable from the fence to the VM2
4. Add a zone terminator (PAE346) to the end of each line. Cover with a Gel cover (MHC017)
5. If using the internal back up battery, connect this before connecting 24Vdc. Note a battery is required if you are going to run a siren and or strobes from the VM2.
6. Connect 24Vdc power to the VM2
7. Check the cable LEDs are showing as green (ok).
8. Connect to the VM2 Virtual Keypad (see Virtual Keypad section)
9. Put the system into test mode and check it
10. Tune the threshold, event limit and window settings for your site to get the best balance between sensitivity to attack and false alarms.
11. Perform a siren test
12. If using an internal backup battery, check the battery and AC fail by turning the 24Vdc supply off.
13. Create an alarm and check that the siren operates and that the User Interface(s) reports the alarm correctly.

Ensure that the user understands how to change the User PIN and is in possession of this Installer/User Manual and the installer's contact details.

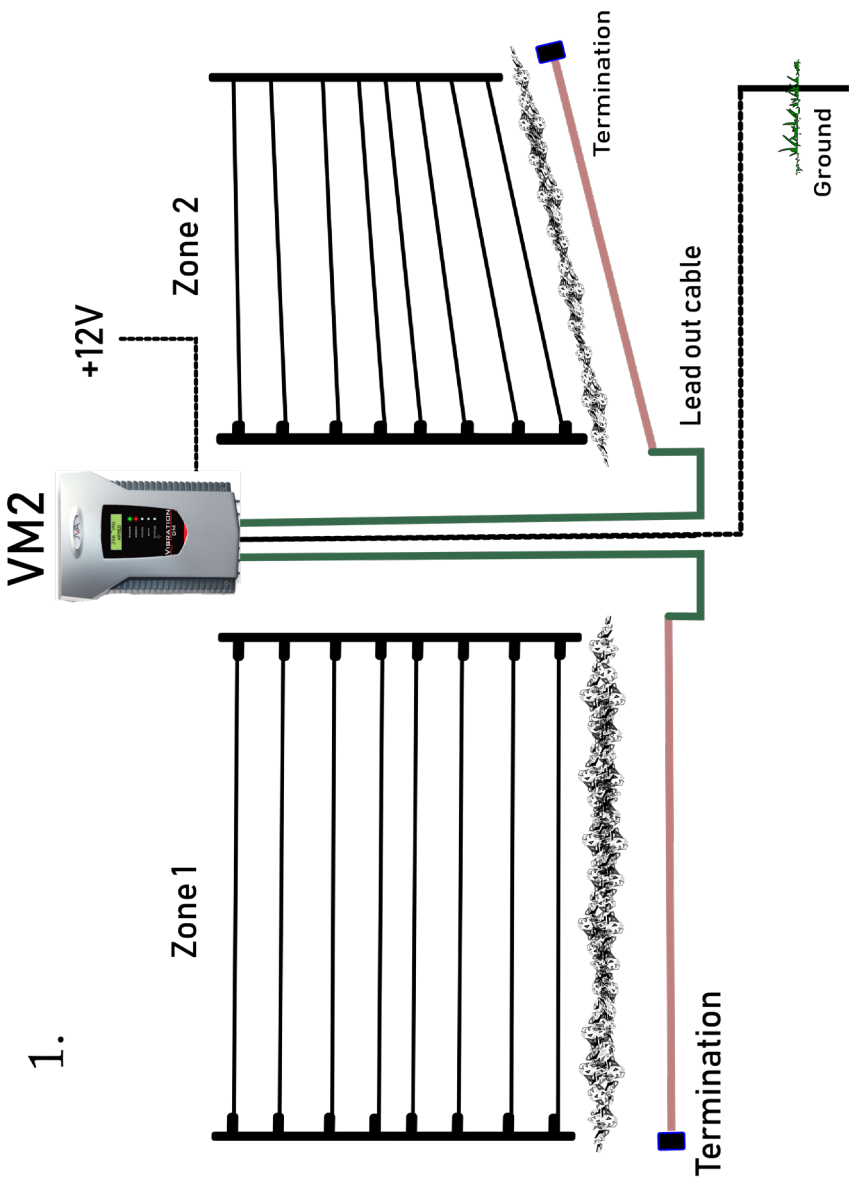

## Installation

## 5.2 SENSOR WIRING

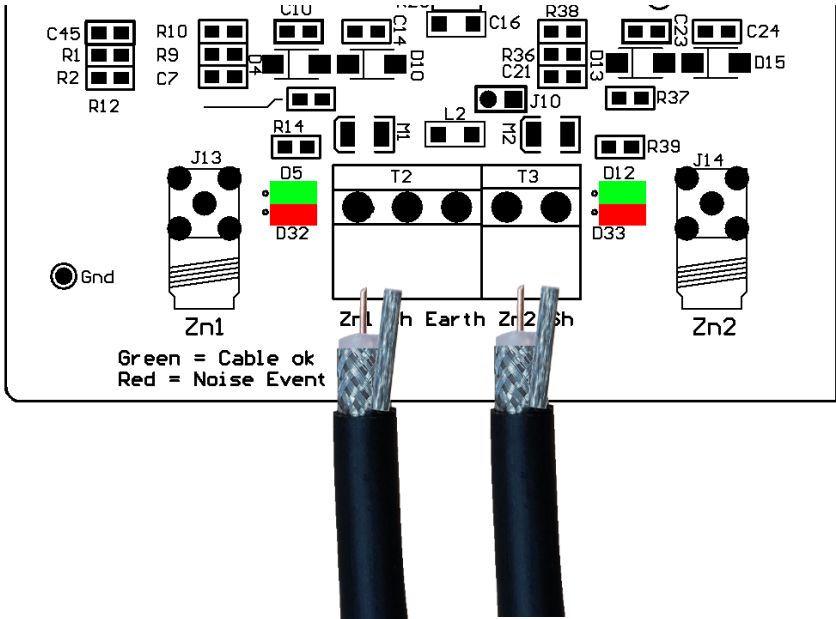

NOTE: The earth terminal must be connected to stop 50/60Hz noise from affecting the system

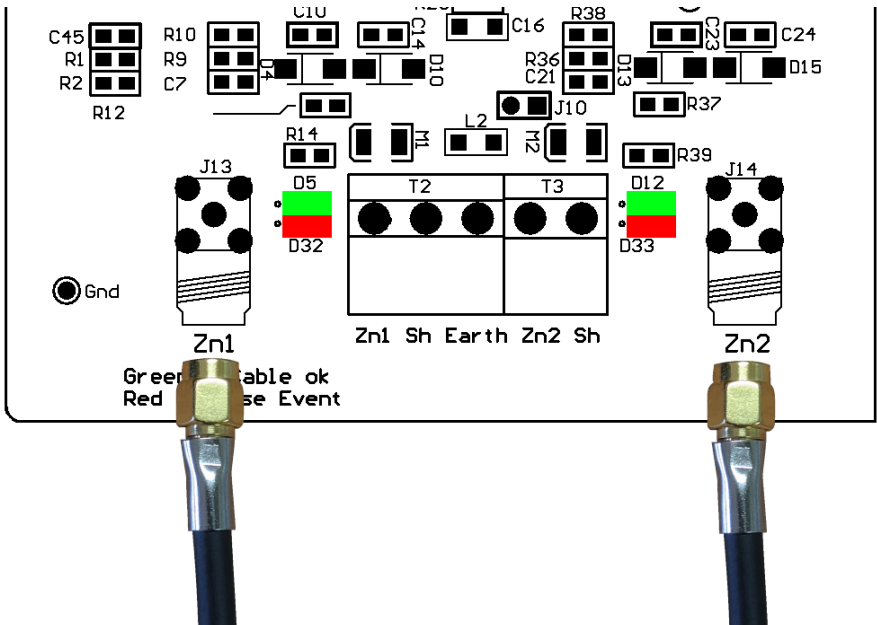





## 5.5 4-LINE KEYPAD

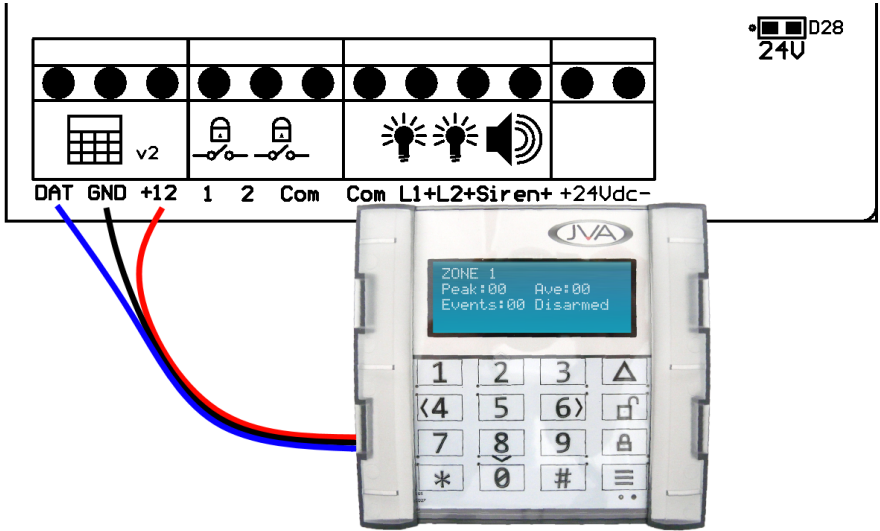

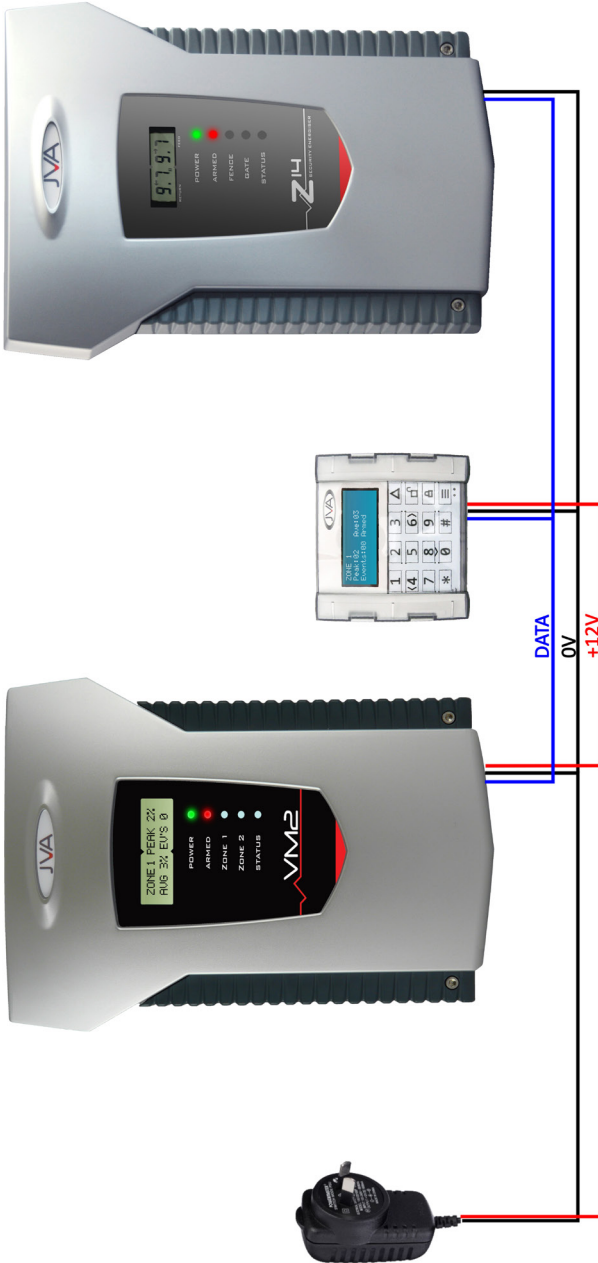

## 6 CABLE HANDLING

---

This section contains information on how to make sure the sensor cable is not damaged in handling or installation.

It also shows how to and where to place the cable for best results for a number of typical applications.

### 6.1 CABLE CARE

- Don't kink it
- Don't nick the outer
- Don't let the core slide out
- Don't stretch or break the core

### 6.2 JOINING AND TERMINATING THE CABLE

The cable will need to be joined if you are using a non sensitive lead out cable. Such lead out **MUST** be coaxial cable such as RG59, do not use multi-core alarm cable, twin flex or Cat5/6 cable. Even though this system does not use high frequency it is very sensitive to induced voltages from external sources such as 50Hz mains electricity.

Join standard RG59 cable to feed into your active zones, or to cross any areas where detection is not required. Sealed cable joiners are available.

The conductors in the cable must remain insulated from the earth and any metal structure.

Use a weather proof junction box and standard double entry terminal strip, or a Gel filled cable joiner kit .

Do not run this cable in the same conduit as electric fence lead out cable.

### 6.3 METHOD FOR BURYING CABLE

The VM2 was designed primarily as an anti-dig sensor system. For best results bury the sensor cable in coarse sand or gravel.

Note from research:

- Check direct burial rating or coax cable (Direct burial or flooded)
- Precise depth
- Cable should be kept away from objects such as trees and light poles, these can cause seismic waves underground that the cable could pick

up

- Avoid burying next to metal
- Ensure that pools of water do not sit on top of the cable

## 6.4 WEBSITES WITH USEFUL INFORMATION

<https://www.sensoguard.com/2018/11/04/perimeter-intrusion-detection-comparison-between-seismic-fiber-optic-and-leaky-coax/>

<https://www.deasecurity.com/media/en/pdfs/DEA-Informative-Brochure-SISMA-CP-50.pdf>

## 6.5 METHOD FOR ATTACHING TO FENCE

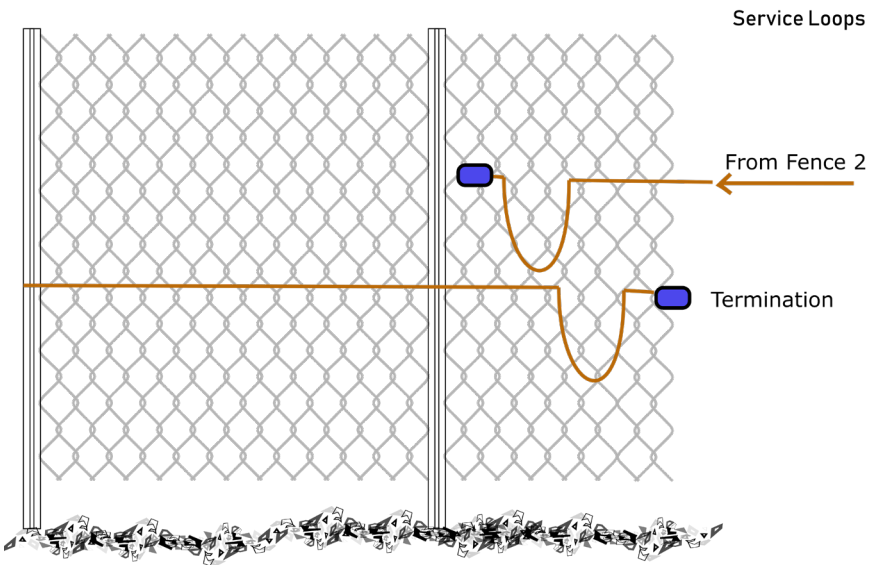

# 7 TUNING

This section contains information on how to adjust the adjustable parameters to get the best balance between sensitivity and false alarms.

The VM2 compares the sounds it picks up on the sensor cable to a preset limit called the Threshold. Any sound that exceeds the adjustable Threshold is called an Event. If the number of Events in a preset Window of time, exceed the Event Limit then that zone will go into alarm. An extra Event is counted if the signal exceeds the threshold for longer than the Sample Time. This means that one long loud sound can create several Events. Note that the front end of the VM2 is done in hardware not sampling software. This means it will not miss an event even if the event is much smaller than the Sample Time.

The main parameters work in this way:

Parameter	Lowering this	Raising this
Threshold	Increases Sensitivity, generates more Events	Reduces false alarms
Events Limit	Increase sensitivity	Reduces false alarms
Window	Reduces false alarms	Increases sensitivity
Sample Time	Increase sensitivity	Reduces false alarms

## 7.1 TEST MODE

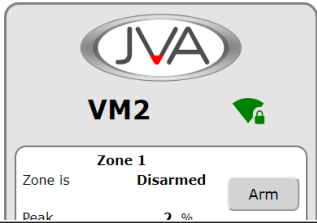
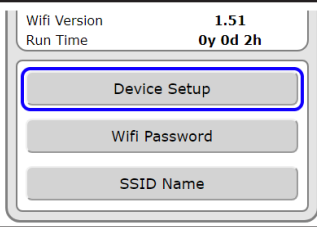
<p>Use the Virtual Keypad to access Test Mode.</p>	
<p>Scroll to the bottom of the page. Press the Device Setup button and enter the Installer PIN: 012345</p>	

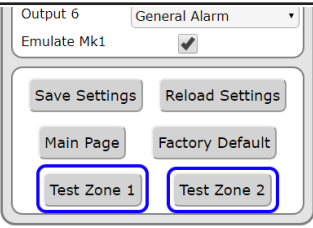
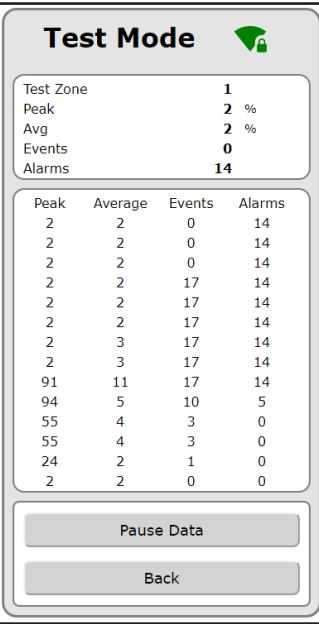
<p>Again scroll to the bottom of the page and click on either Test Zone 1 or Test Zone 2 button.</p>																																																																							
<p>Assuming the cable is attached and properly terminated (the Cable status LED is Green). The VKP will show the Peak and Average sound recorded. It will also show the number of events triggered in each window of time (configured).</p> <p>If enough events are seen, the Alarms number will increment, however the siren will not sound.</p> <p>The test mode screen can be Paused if you want to take a screen capture of the information displayed.</p>	 <table border="1" data-bbox="554 351 845 454"> <thead> <tr> <th>Test Zone</th> <th>1</th> </tr> </thead> <tbody> <tr> <td>Peak</td> <td>2 %</td> </tr> <tr> <td>Avg</td> <td>2 %</td> </tr> <tr> <td>Events</td> <td>0</td> </tr> <tr> <td>Alarms</td> <td>14</td> </tr> </tbody> </table> <table border="1" data-bbox="554 462 845 766"> <thead> <tr> <th>Peak</th> <th>Average</th> <th>Events</th> <th>Alarms</th> </tr> </thead> <tbody> <tr><td>2</td><td>2</td><td>0</td><td>14</td></tr> <tr><td>2</td><td>2</td><td>0</td><td>14</td></tr> <tr><td>2</td><td>2</td><td>0</td><td>14</td></tr> <tr><td>2</td><td>2</td><td>17</td><td>14</td></tr> <tr><td>2</td><td>2</td><td>17</td><td>14</td></tr> <tr><td>2</td><td>2</td><td>17</td><td>14</td></tr> <tr><td>2</td><td>3</td><td>17</td><td>14</td></tr> <tr><td>2</td><td>3</td><td>17</td><td>14</td></tr> <tr><td>91</td><td>11</td><td>17</td><td>14</td></tr> <tr><td>94</td><td>5</td><td>10</td><td>5</td></tr> <tr><td>55</td><td>4</td><td>3</td><td>0</td></tr> <tr><td>55</td><td>4</td><td>3</td><td>0</td></tr> <tr><td>24</td><td>2</td><td>1</td><td>0</td></tr> <tr><td>2</td><td>2</td><td>0</td><td>0</td></tr> </tbody> </table>	Test Zone	1	Peak	2 %	Avg	2 %	Events	0	Alarms	14	Peak	Average	Events	Alarms	2	2	0	14	2	2	0	14	2	2	0	14	2	2	17	14	2	2	17	14	2	2	17	14	2	3	17	14	2	3	17	14	91	11	17	14	94	5	10	5	55	4	3	0	55	4	3	0	24	2	1	0	2	2	0	0
Test Zone	1																																																																						
Peak	2 %																																																																						
Avg	2 %																																																																						
Events	0																																																																						
Alarms	14																																																																						
Peak	Average	Events	Alarms																																																																				
2	2	0	14																																																																				
2	2	0	14																																																																				
2	2	0	14																																																																				
2	2	17	14																																																																				
2	2	17	14																																																																				
2	2	17	14																																																																				
2	3	17	14																																																																				
2	3	17	14																																																																				
91	11	17	14																																																																				
94	5	10	5																																																																				
55	4	3	0																																																																				
55	4	3	0																																																																				
24	2	1	0																																																																				
2	2	0	0																																																																				

Assuming there is a quiet environment, what you are seeing on the screen is your base line measurements. Hopefully the sound % figures are low and there are no events.

If you have an average level of over 50% something may be wrong. Check that the earth terminal on the VM2 is connected to a cabinet or site earth. You may also consider reducing the overall sensitivity of this zone fitting the Pad jumper to J11 (Zone 1) or J12 (Zone 2).

If your cable is accessible you can check it is “live” by tapping on the sensor cable. Tapping with a pen should create a peak of close to 100% and some events. Continuous tapping should generate an alarm.

Create the sounds of an intrusion on your fence or boundary and measure these. You will need someone standing by the VM2 recording the readings displayed on the VKP. The screen capture feature of most phones can be useful here.

For a false alarm free system, the sound levels for intrusion events must be much higher than your base level (normal) sound levels.

Set the zone Threshold above the base level and below the intrusion peak sound level.

Leave the Window setting where it is. Reduce the Events Limit until you are happy that an intrusion sound will cause an Alarm.

If you change the settings for Threshold, Events Limit or Window, re-enter test mode and check that an intrusion sound causes an alarm.



## 8 CONTROL

---

Your JVA VM2 security energizer has been designed for ease of operation. It may be armed and disarmed using any of the following:

- The Virtual Keypad
- Z-Series Keypad (LCD or Touch)
- External switch connected to the control inputs IN1, IN2
- Remote control radio receiver connected to IN1, IN2
- JVA Cloud Gateway modules (Cellular / WiFi)
- Windows PC running JVA Perimeter Patrol
- Low level interface (wired to control inputs and relay outputs) from a third party security alarm panel or Physical Security Information System (PSIM)

NOTE: More than one method may be used in the one installation.

### 8.1 ARMING THE FENCE USING THE KEYPAD.

Press the Arm Button on the Keypad and then enter your **User PIN #** (Default User PIN is 1234).

Make sure the red ARM lights comes on.

- The keypad will beep to confirm that the system is armed.
- The signals on the detection wire will now be able to generate alarms.
- To disarm the system, press the Disarm Button and enter your User PIN and press #.

### 8.2 WHEN AN ALARM OCCURS

If the system is armed and the fence is tampered with, the fence light will flash and then remain on. A siren or strobe connected to the unit will turn on. If the VM2 is connected to an alarm system for monitoring, an alarm signal will be sent to the alarm company monitoring the alarm system.

### 8.3 TO SILENCE THE ALARM

Enter **1470#** on the Keypad. This will silence the Siren but not disarm the system; the armed light will remain on and the Strobe will still indicate the Zone that was in Alarm.





Entering this command will force the Siren into its “Siren Off Time”. If the fault remains on the Fence, then the Siren will sound again after the “Siren Off Time” has elapsed. If however, the fault is cleared, then the Siren will be ready to sound again for the next Alarm.

Alternatively, disarming the VM2 will silence the alarm.

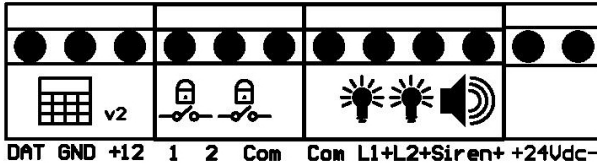
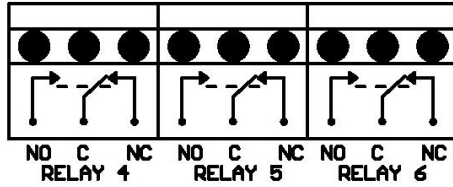
## 8.4 CHANGING THE USER PIN

- Enter the current **User PIN** (default is 1234) and press **\*0#**. This enters User Programming mode.
- Enter your new **User PIN** (must be 4 digits) and then **#**.
- Press **\*#** to exit User Programming mode.
- Make sure your new User PIN works by using it to arm the energizer



Label	Type	Description
 KEYPAD	3 Way	Supplies power and data for an external keypad. The +12 source on these terminals is protected with 0.9A self resetting fuse.
 1	1 to Com	Zone 1 control input (dry contact). Linking input 1 to Com will arm Zone 1.
 2	2 to Com	Zone 2 control input (dry contact). Linking input 2 to Com will arm Zone 2.
 L1+	L1+ to Com	Strobe output for Zone 1. Switched 12V output (30W max, shared between Siren and Strobes). A buffer relay should be used when connecting this output to an alarm panel. Low side switched.
 L2+	L2+ to Com	Strobe output for Zone 2. Switched 12V output. A buffer relay should be used when connecting this output to an alarm panel. Low side switched

Label	Type	Description
 Siren+	Siren+ to Com	Siren output for the VM2. Switched 12V output. A buffer relay should be used when connecting this output to an alarm panel. Low side switched
24Vdc	3 Way	24Vdc 1.5A power. If a battery is not used, the unit can be powered from 12-24Vdc.
Relay 4	3 Way	Dry contact relay. Default operation is Zone 1 or Zone 2 Armed
Relay 5	3 Way	Dry contact relay. Default operation is Zone 1 or Zone 2 Alarm
Relay 6	3 Way	Dry contact relay. Default operation is General Alarm

## 9.1 POWER OPTIONS

The VM2 has 2 sources of power, 24Vdc and 12Vdc (battery). If using solar power and an external battery, connect the battery to the battery leads.

Due to the stored energy in a 24Vdc plug-pack, a mains fail fault may take up to 5 minutes to be reported.

NOTE: Use only rechargeable batteries.

## 9.2 STANDBY BATTERY

Should there be a loss of mains power, the VM2 will report a mains fail fault. If the loss of power is prolonged, the battery may discharge power and become ineffective. If the battery voltage drops below the set-point, the VM2 will report a low battery fault. If the battery is fully depleted, the unit will not operate as expected.

If the standby battery requires replacement, the VM2 will report a Flat Battery.



## 9.3 STATUS CODES

Status LED Number of Flashes	Interpretation	Corrective Action
1	Tamper detected	The Input Tamper hardware needs reviewing.
2	Mains supply fail	Restore mains power
3	Low battery, bad battery	Charge or replace battery
4	PCB service fault	Seek advice from your installer or distributor

If a minor error occurs, it will self-clear if the error condition is removed.

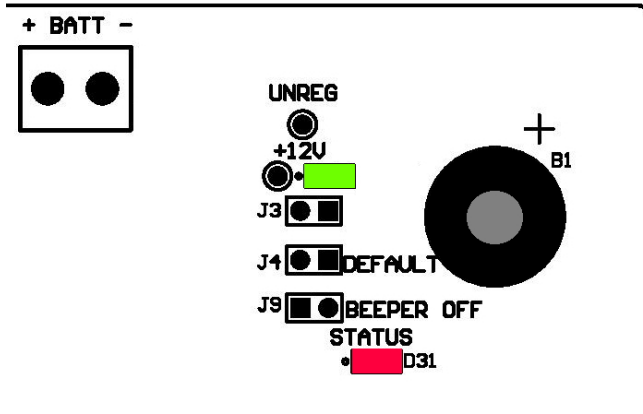
A PCB fault will disarm the VM2. The Virtual Keypad and VM2 will report more information about a PCB fault.



	Function	Purpose
+12V 	Power LED	To indicate that the VM2 has 12V power
J3	Inhibit Mains fail error	J3 is fitted to inhibit Mains fail errors if the intention is to operate the energizer on DC only (as in solar power systems).
J4	Factory default jumper Off to return programmable options to factory defaults on power up.	If the VM2 needs to be defaulted to factory settings, remove all power (24Vdc and battery) and remove the J4 jumper. Reapply the mains and the battery power. Reapply the J4 jumper and the VM2 will be factory reset.
J8	Beeper Bypass	Fit the J8 jumper to both pins to bypass the beeper.
STATUS 	Status LED	Indicates Mains/Batter/PCB errors

## How to fit a Jumper/Bridge/Shunt

A fitted Jumper is shown as closed in the diagram below. If a jumper is not to be fitted it can be placed over a single pin, this is shown as open in the diagram below.

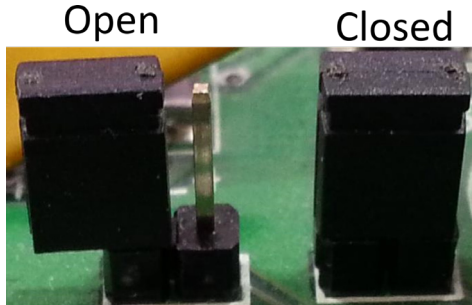

## 10 PROGRAMMING OPTIONS

The VM2 has permanent memory in which the programming options are stored. These are factory pre-set but can be field programmed using a Z-Series keypad.

### 10.1 CHANGING THE INSTALLER PIN

The installer PIN may be changed using the Virtual Keypad, or using the 4-line Keypad.

To change the Installer PIN via the 4-line keypad, follow the two steps below.

Step 1	Current 6 digit Installer PIN			*	0	#
Step 2	0	0	New 6 digit Installer PIN			#

If you cannot remember your Installer PIN, return the unit's memory to factory defaults. Remove power (24Vdc off and disconnect the battery), open the VM2, remove jumper J4 and reconnect the battery for about 10 seconds. Re-fit J4. Turn on 24Vdc power.

All programming options will be return to factory defaults.

### 10.2 PROGRAMMING MODE

See the Quick Start section of this manual which shows how to access Programming mode.

### 10.3 PROGRAMMING OPTIONS

#### 10.3.1 Group ID

A group of Z series devices connected on a wired Keypad Bus must have unique Group IDs. There must be a master device (Group ID 1) in the group or the system will not work. The VM2 should be set to Group ID 2 to 15 if it is wired into a group with Z series energisers or monitors.

If a WiFi GPIO is wired to the Keypad Bus, this device is the group master (ID 1). All other devices should be set to unique values (ID 2 to 15).

**The Default is Group ID 1.**

#### 10.3.2 Zone Threshold (1 and 2).

If the VM2 detects a peak noise above this value, it will register an event. This should be set above the normal background noise level on your site.



This is often the only setting that will need to be adjusted on a typical site.

**The Default setting is 25%.**

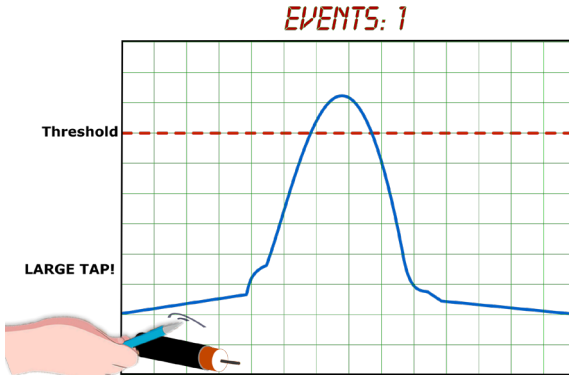

### 10.3.3 Zone Events (1 and 2)

If there are more than this number of Events in a single Window of time, then there will be an alarm. Increase this to reduce false alarms. Adjust Threshold before changing this setting.

**The Default setting is 5.**

### 10.3.4 Zone Window (1 and 2)

This setting determines the amount of time in the moving Window used to count Events. This means that 5 events spread over a long period will not trigger an alarm. Five events in rapid succession (within the one Window) will trigger an alarm if the Events Limit is below 5. Reduce this to reduce false alarms. Adjust Threshold before changing this setting.

**The Default setting is 3 seconds.**

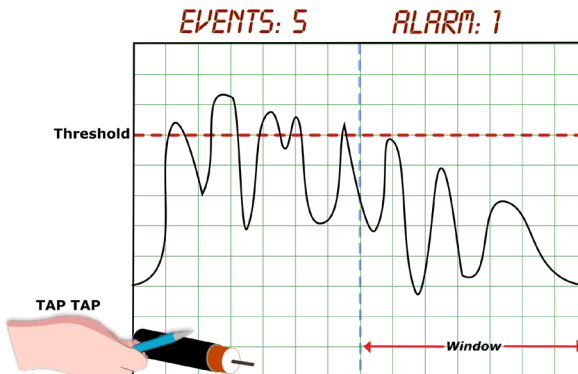

### 10.3.5 Sample Time

This setting can be used to reduce the number of Events that occur from a single strike to a fence. This is usually the last setting to adjust of all those above.

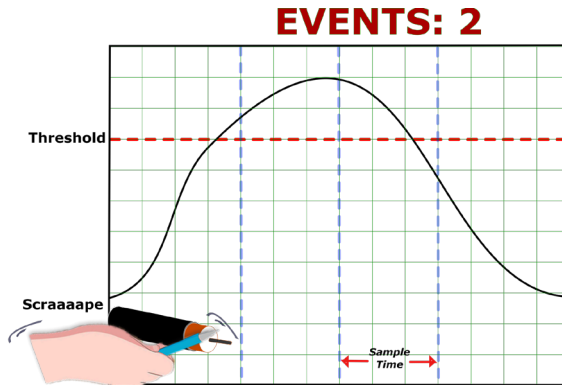

### 10.3.6 Dynamic Noise Rejection (DNR)

Dynamic Noise Rejection can be enabled per zone. If activated the system actively ignores this noise floor. For example, if the average noise is at 10% and the Zone Threshold is set to 10% the alarm threshold will effectively be at 20%.

If this addition gets too close to the signal ceiling then a HUM trouble is generated.

### 10.3.7 Battery Float

The VM2 contains an inbuilt battery charger for a standby 12V sealed lead acid battery. If you are not using the battery ignore this setting. This setting adjusts the voltage at which a lead acid battery will be charged and held at when fully charged. Please check your battery manufacturer's specifications for the correct value for standby use.

NOTE: Raising this setting will not increase the speed at which a flat battery is charged. Setting it too high will damage the battery. The VM2 will run a battery "boost" cycle after an mains fail event. This will charge the battery to 1V higher (14.7V) than the normal float setting. Boost cycles are limited to once per 8 hours.

Note that the temperature of the PCB is used to adjust this value. This assumes a lead acid battery type.

If you are measuring the float voltage using a multimeter at the battery

leads without a battery connected you must do this within 10 minutes of removing the battery, otherwise the controller will determine that there is no battery connected and stop trying to charge it.

**The Default setting is 13.7V.**

### 10.3.8 Battery Alarm

If the battery voltage drops below this value, the Low Battery event is triggered.

This value should be more than 0.5V below the Battery Float value. The Low Battery Alarm will clear when the supply has increased to 1.0V above the Low Battery Level.

**The default setting is 11.0V.**

### 10.3.9 Gate Delay

An Input must be configured for a Gate Alarm to use this function. This Input is usually also configured for Normally Closed operation so that the input is 'open circuit' when the gate opens. If this gate input remains open for longer than the Gate Delay continuously, the gate alarm is triggered.

**The default setting is 60 seconds.**

### 10.3.10 Siren On Time

This option sets the duration of time that the siren will remain on after a fence alarm occurs. After this time the siren will turn off for the **Siren Off Time**. The siren will sound again if the alarm is still present after this off time has passed. The on time may be the subject of local regulations to stop an alarm causing undue disturbance to neighbours, etc.

**The Default setting is 180 seconds (3 Minutes).**

### 10.3.11 Siren Off Time

This option sets the amount of time the siren will be off for after the Siren On Time has expired. If an alarm is still present after this off time the siren will sound again.

**The Default setting is 5 Minutes.**

### 10.3.12 Siren Cycles

This option sets the maximum number of times the siren will sound for the **Siren On Time** if the alarm continues. This may be limited by local regula-

tions to stop an alarm causing undue disturbance to neighbours etc.

Note: This is the maximum number of cycles for 1 continuous alarm, intermittent alarm events could cause more than this number of siren soundings.

**The Default setting is 3.**

### 10.3.13 Auto Rearm

This option sets the time which must elapse before another alarm will sound the siren after the first alarm has timed out.

If an event occurs which triggers the siren, any other events which would otherwise trigger the siren (such as a gate alarm) will be ignored while the siren is sounding and until after the Auto re-arm time has passed.

**The default is 0 Seconds (Immediate ).**

### 10.3.14 Gate Alarm Time

The Gate Alarm will trigger if the Input configured to the Gate Alarm Function remains open for longer than the Gate Alarm Time.

**The Default setting is 60 seconds.**

### 10.3.15 Chime Mode (Option 14)

This option allows the VM2 internal beeper to be used as a door chime for the gate function. When set to None, the keypad beeper is used to indicate correct keypad operation only. When set to Door Chime mode, both

NOTE: “Gate Function” must be selected for an input. If set to siren, both beepers mimic the siren function.

Gate Beeps plus Siren will give 2 beeps on gate open and 4 on close, plus continuous for an alarm. This option is different as beeps are on the keypad only, not the internal beeper.

Function	Description
None	The Beeper will not sound.
Door Chime	The beeper will sound when the gate input opens, even if the VM2 is disarmed.
Siren	The beeper will mimic the Siren function.

Function	Description
Fence Alarm	The beeper will remain on while a Fence Alarm is triggered.
Gate plus Siren	The beeper will mimic the Siren function.

### 10.3.16 Input Function

Function	Description
Arm Device	The Input will arm/disarm both Zone 1 and Zone 2.
Arm Zone 1	The Input will arm/disarm only Zone 1.
Arm Zone 2	The Input will arm/disarm only Zone 2.
Arm Group	The Input will send a command on the Keypad Bus to all devices in the Group to Arm/Disarm.
Instant Alarm	The Input will trigger an alarm after 200ms of continuous activation.
Alarm 3 sec	The Input will trigger an alarm after 3 seconds of continuous activation.
Gate Alarm	The Gate Alarm will trigger after Gate is open for longer that the Gate Alarm Time.
Pass Through	The Input does not affect the VM2. The input state is passed through to Perimeter Patrol.
Tamper	The Input will generate a Tamper Alarm when triggered.
Tamper/Shut-down	The Input will generate a Tamper Alarm when triggered and the VM2 will disarm.

**Input 1 Default: Arm Zone 1.**

**Input 2 Default: Arm Zone 2.**

### 10.3.17 Input Type

Type	Description
N/O	Normally Open (Active when Closed)
N/C	Normally Closed (Active when Open)
Tag	Momentary Toggle (Toggle between states)

**Input 1 Default: N/O.**

**Input 2 Default: N/O.**

### 10.3.18 Output/Relay Function

The table below is for use for the relay programming options mentioned in the above table.

Function	Description
Zone 1 Alarm	Triggered while Zone 1 is in alarm.
Zone 1 or Disarmed	Triggers when Zone 1 is disarmed or in alarm.
Zone 1 Armed	Zone 1 is armed.
Zone 2 Alarm	Triggered while Zone 2 is in alarm.
Zone 2 or Disarmed	Triggers when Zone 2 is disarmed or in alarm.
Zone 2 Armed	Zone 2 is armed.
Zone 1 or 2 Alarm	Triggered while Zone 1 is in alarm or Zone 2 is in alarm.
Zone 1 or 2 Armed	Triggered while Zone 1 is armed or Zone 2 is armed.
General Alarm	Triggers on Mains Fail, Tamper, Low Battery/Bad Battery or Internal error.
Siren Zone 1	Siren function for Zone 1, Gate Alarm or Tamper.
Siren Zone 2	Siren function for Zone 2 only.
Siren Zone 1 or 2	Siren function for Zone 1, Zone 2, Gate Alarm or Tamper.
Strobe Zone 1	Triggers on Zone 1 alarm, Gate or Tamper. Latched on until the Zone is re-armed, or alarms are cleared.
Strobe Zone 2	Triggers on Zone 2 alarm. Latched on until the Zone is re-armed, or alarms are cleared.
Strobe Zone 1 or 2	Triggers on Zone 1 alarm, Zone 2 alarm, Gate or Tamper. Latched on until the VM2 is re-armed, or alarms are cleared.
Supply Fail	Triggers when the 24Vdc supply fails (due to Mains fail, or transformer fault)
Battery Low/ Faulty	Triggers on low or bad battery
Tamper	Triggers when an Input programmed for the Tamper function is activated.

Function	Description
Gate Alarm	Triggered when the Input programmed for the Gate Alarm remains open for longer than the Gate Time.
Input 1 Alarm	Triggered when Input 1 activates. Requires the Input to be programmed as Instant Alarm or 3 second Alarm.
Input 2 Alarm	Triggered when Input 2 activates. Requires the Input to be programmed as Instant Alarm or 3 second Alarm.
Host Control FailSafe	This output is controlled by Perimeter Patrol. If Perimeter Patrol disconnects, the alarm will trigger.
Host Control	This output is controlled by Perimeter Patrol.
Group Armed	Triggered when all zones on the Keypad Bus are armed.
Group General	Triggered when one zones on the Keypad Bus indicates a General Alarm.

NOTE: The siren and strobe switched 12V outputs can be used to drive external buffer relays.

Specification Name	Specification
24v dc Power Consumption - no battery or battery fully charged	110mA Not including keypad or auxiliary power
24v dc Power Consumption - battery being charged	1.25A
12V Power consumption	200mA Not including keypad or auxiliary power
Coaxial cable excitation voltage (measured without a cable terminator connected)	45Vdc
Siren and Strobe Outputs	Self-resetting fuse protection, switched 12V, rated at 30W (combined). A battery must be used.
Switched outputs	Three 30V 1A "Form C" change-over contacts. Common contact can be linked to +12V
Enclosure	IP4x ABS plastic
Size	300mm high, 190mm wide, 115mm deep
Weight – packed, no battery	1kg



## 12 Z-SERIES KEYPADS

There are 2 different keypads that can connect to the keypad bus of a Z-Series device:

- PTE0240 4-line keypad
- PTE0230 Touch Keypad

A keypad can be used to control, program and monitor the devices on your fence.

### 12.1 PTE0240 4-LINE KEYPAD



JVA's mid-range keypad features include:

- Quick Arm/Disarm keys
- 4-line Backlit LCD Display
- Menu driven interface
- Menu driven device programming
- 500 entry event log with date and time stamps



JVA's most advanced keypad features include:

- Touch screen with clean user interface designed for ease of use
- Quickly arm or disarm the entire site or granularly via the Zones screen
- Emails on alarm
- View all active and latched alarms in the alarms screen
- Program all Z-Series devices through an intuitive system, without having to remember or refer to a manual for key sequences. With the new MK2 protocol, these devices can be all programmed together without having to isolate each device individually
- Quiet mode: set a time where the Keypad won't brighten the screen or set off loud sirens unless it is critical such that you might enjoy a restful night's sleep.
- The ability to monitor and log all user actions
- Large detailed event log

## 12.3 CONNECTING MULTIPLE KEYPADS

Function	Code	Default Code
Re-analyse the Keypad group	[User Pin]*68#	1234*68#

Up to three keypads may be used to remotely monitor and control Z-Series devices.

To operate correctly, each keypad must be configured to use a unique keypad address. This is best achieved by connecting one keypad (at a time) to the master Z-Series device and updating the keypad address. Once all keypads have a different address, all can be connected to the system. Enter the above command using the keypad (at address 1).

## 12.4 KEYPAD CONFIGURATION NOTES

Zone 1 (the master) must be connected to the group. If it is not connected to the other Z-Series devices in the group, the keypad will report a communications failure with all the zones.

After connecting an LCD keypad to a group of devices, enter \*68# on the keypad to 'discover' the connected energizers. Ensure that all Z-Series devices are disarmed first.

# Z-Series Keypads

## 12.5 4-LINE KEYPAD COMMANDS

Default Installer PIN	012345			
Default User PIN	1234			

Command	Key1	Key2	Key3	Key4	Key5	Key6	Key7	Key8	Key9	Key10
Arm/Disarm		USER PIN			#					
Silence the Energizer Siren	1	4	7	0	#					
Enter Programming Mode		INSTALLER PIN					*	0	#	
Enter Keypad Programming Mode		INSTALLER PIN					*	0	1	#
Exit Programming (Any Mode)	*	#								
Change a User PIN, 4 Digits		USER PIN			*	0	#	[New PIN]	#	
Arm All Zones (Multi-Zone Groups)		USER PIN			*	1	0	#		
Arm Specific Zone (up to Zone 15)		USER PIN			*	1	Zone Number		#	
Disarm All Zones		USER PIN			*	2	0	#		
Disarm Specific Zone (up to Zone 15)		USER PIN			*	2	Zone Number		#	
Switch to Low Power Mode (All Zones)		USER PIN			*	4	1	#		
Switch Specific Zone to Low Power		USER PIN			*	4	1	Zone No.	#	#

Command	Key1	Key2	Key3	Key4	Key5	Key6	Key7	Key8	Key9	Key10
Switch to High Power Mode (All Zones)		USER PIN			*	4	2	#		
Switch Specific Zone to High Power		USER PIN			*	4	2	Zone No.		#
Arm Gate Zone only		USER PIN			*	4	#			
Bypass Siren (All Zones)		USER PIN			*	5	2	#		
Bypass Specific Zone Siren		USER PIN			*	5	2	Zone No.		#
Re-enable Siren		USER PIN			*	5	1	#		
Re-enable Specific Zone Siren		USER PIN			*	5	1	Zone No.		#
Bypass Gate Alarm (All Zones)		USER PIN			*	5	4	#		
Bypass Specific Gate Alarm		USER PIN			*	5	4	Zone No.		#
Re-enable Gate Alarm (All Zones)		USER PIN			*	5	3	#		
Re-enable Specific Gate Alarm		USER PIN			*	5	3	Zone No.		#
Arm in Agricultural Mode (No Alarms)		USER PIN			*	9	Zone No.			
Reset and Display Firmware Version		USER PIN			*	6	8	#		
Reset and Return to Factory Defaults		INSTALLER PIN			*		*	6	8	#

Energizer Function	Key1	Key2	Key3	Key4
Clear Alarm Memory	*	1	#	
Display the Group ID of the Energizer	*	2	6	#
Siren Test	*	6	3	#
Battery Test	*	6	4	#

Keypad Specific Function	Key1	Key2	Key3	Key4
Re-Analyse the Energizer Group	*	6	8	#
Keypress Beep On/Off	*	5	1	#
Chimes On/Off	*	5	3	#
Error Tones On/Off	*	5	4	#
Keypad Alarm Tones On/Off	*	5	5	#
Change Backlight Mode	*	8	#	
Display Keypad Model	*	9	#	



Electric Fencing Products



DEALER



[WWW.JVA-FENCE.COM](http://WWW.JVA-FENCE.COM)