

RF INTERFACE USER MANUAL

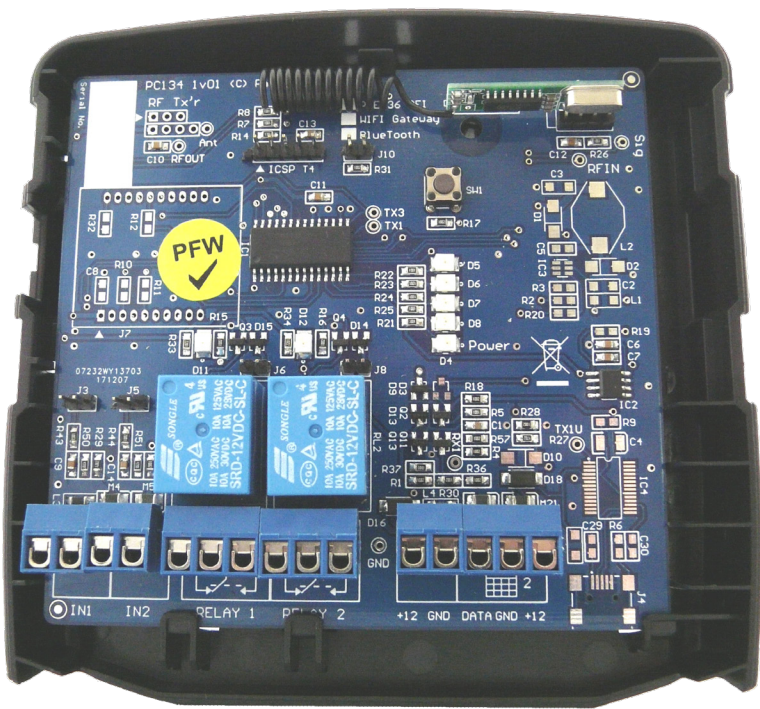

CONTENTS

1	INTRODUCTION	6
1.1	RF SENSORS	6
1.2	STAND-ALONE ACCESSORIES	7
1.3	4-LINE KEYPAD	8
1.4	TOUCH KEYPAD	8
1.5	CLOUD ROUTER™	9
1.6	USEFUL RESOURCES	9
2	FEATURES AND BENEFITS	10
3	SPECIFICATIONS	11
4	EQUIPMENT	12
4.1	REQUIREMENTS	12
4.2	OPTIONS	12
5	DESCRIPTION	13
5.1	LED STATUS LIGHTS.	13
5.2	KEYPAD	14
5.3	CONFIGURABLE AUDIBLE INDICATIONS	14
5.4	OUTPUTS	15
5.5	INPUTS	15
6	PAIRING SENSORS	16
6.1	SINGLE PAIR MODE	16
6.2	KEYPAD CODES (PAIRING)	17
6.3	CONTINUOUS PAIR MODE (ADVANCED)	17
6.4	REMOVE LAST PAIRED DEVICE	18
6.5	FACTORY DEFAULT	19
6.5.1	DELETING SENSORS, REMOTE'S AND DEFAULTING PROGRAMMING OPTIONS	19
7	CONTROLLING YOUR RFI	20
7.1	INPUT CONTROL.	20
7.2	JVA KEY FOB.	20
7.3	ROBOGUARD REMOTE	21
7.4	4-LINE KEYPAD	21

7.5	TOUCH SCREEN KEYPAD	22
7.6	CLOUD ROUTER™	22
7.7	CONTROL ARBITRATION	22
8	WHEN AN ALARM OCCURS	24
8.1	RFI DEVICE	24
8.1.1	TO SILENCE AN ALARM	24
8.1.2	TO CLEAR ALARM MEMORY	24
8.2	4-LINE KEYPAD	24
8.2.1	TO SILENCE AN ALARM	24
8.2.2	TO CLEAR ALARM MEMORY	24
8.3	TOUCH KEYPAD	25
8.3.1	TO SILENCE AN ALARM	25
8.3.2	TO CLEAR ALARM MEMORY	25
8.4	CLOUD ROUTER™	25
8.4.1	TO SILENCE AN ALARM	25
8.4.2	TO CLEAR ALARM MEMORY	25
9	RFI INTERFACES	26
9.1	4-LINE KEYPAD INTERFACE	26
9.1.1	RFI RELEVANT KEYPAD CODES	26
9.2	TOUCH KEYPAD INTERFACE	27
9.3	CLOUD ROUTER™ INTERFACE	27
10	INSTALLATION	29
10.1	INSTALLATION STEPS	29
11	WIRING DIAGRAMS	30
11.1	KEYPAD BUS WIRING	30
11.2	INPUT WIRING EXAMPLE	31
11.2.1	DRY CONTACT	31
11.2.2	PULL DOWN TO GROUND	31
11.2.3	PULL UP TO +5V	31
11.2.4	PULL UP TO +12V	31
11.3	OUTPUT WIRING EXAMPLE	32
11.3.1	OFF STATE	32
11.3.2	ON STATE	32

11.3.3	ALARM STATE.	32
11.3.4	12V TO COMMON	32
12	TECHNICAL INFORMATION.	33
12.1	CONTROL, POWER AND IO TERMINALS	33
12.2	STATUS LED (D8) ERROR MESSAGES	34
12.3	JUMPERS	34
12.3.1	HOW TO FIT A JUMPER	35
13	PROGRAMMING OPTIONS	36
13.3.1	PROGRAMMABLE OPTIONS TABLE	36
13.1	PROGRAMMING OPTIONS IN DETAIL.	38
13.2	GROUP ID	38
13.2.1	ZONE 1 - 8 ALARM TYPE	38
13.2.2	INPUT 1 AND 2 HARDWARE TYPE	39
13.2.3	INPUT FUNCTION	39
13.2.4	LOW POWER SUPPLY LEVEL	40
13.2.5	ENTRY DELAY.	40
13.2.6	EXIT DELAY (16xxx#)	40
13.2.7	GATE DELAY (17xxx#).	40
13.2.8	SIREN ON TIME (18x#)	41
13.2.9	SIREN OFF TIME (19x#)	41
13.2.10	SIREN CYCLES (20x#).	42
13.2.11	ZONE COMMUNICATION FAIL TIME (21xxx#)	43
13.2.12	ZONE COMMUNICATION FAIL TIME - LONG (22xxx#)	43
13.2.13	AUTO RE-ARM TIME (23x#).	44
13.2.14	RELAY FUNCTIONS.	44
13.2.15	ANTI-JAMMING (26xxx#).	46
13.2.16	BINARY OPTIONS (27x#).	47
13.2.17	PULSE OUTPUT DURATION (28xxx#).	47
14	Z-SERIES KEYPADS.	48
14.1	PTE0240 4-LINE KEYPAD	48
14.1.1	WIRING THE KEYPAD	48
14.1.2	ARMING/DISARMING USING THE KEYPAD	48
14.1.3	DISPLAY SCREENS.	49
14.1.4	MENUS	51

1 INTRODUCTION

The PTE0236 Radio Frequency Interface (RFI) is designed to monitor 433MHz RF security devices such as Door Sensors, Roboguard Beams, Indoor PIRs and Outdoor PIRs. It can also be paired with RF remote controls (key fob) and Roboguard Handheld Remotes for easy Arming and Disarming. Each paired RF sensor provides a monitored zone for generating an alarm when the sensor detects an intruder.

This unit can operate as a stand-alone alarm system through the addition of a Siren and Strobe; however the addition of a User Interface makes the entire system enjoyable. These options include a 4-Line Keypad and the Cloud Router™ application.

The RFI can be paired to devices encoded with either Keeloq or HS1527 encoders.

1.1 RF SENSORS





1.3 4-LINE KEYPAD



1.4 TOUCH KEYPAD



1.5 CLOUD ROUTER™



1.6 USEFUL RESOURCES

Touch Keypad online user manual: www.jva-fence.com/touchkeypad

Cloud Router™ online user manual: www.jva-fence.com/cloudrouter

4-Line Keypad online manual: www.jva-fence.com/4line

Roboguard Devices: www.roboguard.co.za

Australian designed and manufactured	High reliability and great service
Monitors most standard RF sensors	Flexibility to choose the preferred sensor designs
Monitors the Roboguard RF products	Even more flexibility in security integration
Programmable options	Easy to customise the device to suit varying site requirements
Wall-mountable, robust enclosure with easily detachable PCB chassis.	Ease of installation and maintenance
Two "Form C" Relays with dry contacts for switched voltage Output	Many programmable functions available for each relay output
Two Wired Inputs	Many programmable functions available for each input. E.g. can be connected to a hard wired sensor or a switch used to arm/disarm the device

MORE FEATURES

- Can monitor 8 zones comprising of up to 2 wired zones and up to 8 RF sensors. These include: Roboguard Beams, HS1257 PIRs and door contacts
- Can be paired with up to 20 RF remotes. These include: HS1257, Roboguard (Note 1), Keelog remotes
- Alarms reporting available for each zone with a User Interface
- Powered from a 12V DC external source

NOTE 1 - Each button on a Roboguard remote is programmable. This means that each Roboguard button counts as a paired RF remote

3 SPECIFICATIONS

The specifications table below outlines the power consumption of the RFI and the acceptable voltage and current ranges for different inputs and outputs.

Nominal input voltage	12Vdc
Maximum voltage on IN1 and IN2 input	12Vdc
Maximum RF Sensor distance (line of sight)	50m
Maximum Roboguard Beam distance (line of sight)	200m
Maximum paired RF Sensors and Wire Sensors	8
Maximum paired RF Remotes and Roboguard Buttons	20

WARNING!

- There are no user-serviceable parts in this unit.

4 EQUIPMENT

4.1 REQUIREMENTS

- External 12V source

4.2 OPTIONS

- 12Vdc Siren
- 12Vdc Strobe light
- Roboguard Beam
- Roboguard Repeater Station
- RF/Wired PIR Sensor
- RF/Wired Door Contact
- RF Remotes
- Roboguard Remotes
- 4-Line Keypad (Note 1)
- Touch Keypad
- Cloud Router™ Web Application
 1. Any PC
 2. Smart Phone

Notes:

1. While the Keypad is not essential for normal operation, it is required to adjust the programmable options.

For more information please see www.jva-fence.com.au

5 DESCRIPTION

5.1 LED STATUS LIGHTS

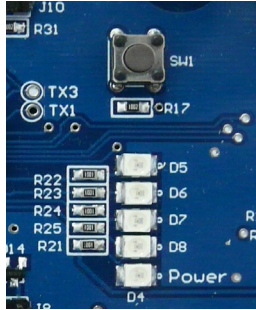

The status LEDs on the RFI allows the user to quickly ascertain the current status of the unit and if any action needs to be taken. Below is a brief description of each LED and the information it conveys.

Status Light	Designator	Description
Armed/Pairing (Red LED)	D5	On when the unit is armed Off when disarmed Slow Flashes when pairing to sensors 2 Fast Flashes when pairing Roboguard Beams Continuous Fast Flashes when pairing with remote's
Alarm (Red LED)	D6	On when there is any alarm Off when no alarm is detected or is disarmed
RF Signal (Red LED)	D7	Flashes when a paired RF sensor or remote is transmitting
Error (Red LED)	D8	Used to flash error codes. See "12.2 Status LED (D8) Error Messages" on page 34
Power (Green LED)		On when the unit has power

5.2 KEYPAD

A keypad (either Touch or 4-Line) can be used to remotely monitor and control the RFI. It is also required to change the programmable options. For more on programming the device see "Programming Options" on page 29.

5.3 CONFIGURABLE AUDIBLE INDICATIONS

When the RFI is connected to a keypad, the keypad beeper will sound to notify users that a zone has alarmed. Many of the zone functions can also be programmed to provide a chime sound for when the zone is disarmed. The chime functionality can be enabled or disabled.

Trigger	Description
Entry Zone when disarmed	If "Chime on Entry" is enabled, an Entry Zone will sound a Chime on the keypad when the zone is triggered
Exit Zone when disarmed	If "Chime on Exit" is enabled, an Exit Zone will sound a Chime on the keypad when the zone is triggered
Entry/Exit Zone when disarmed	If "Chime on Exit" or "Chime on Entry" is enabled, an Entry/Exit Zone will sound a Chime on the keypad when the zone is triggered
Chime Zone when disarmed	This zone will always sound a Chime on the keypad when the zone is triggered
Exit Chimes	After arming an Exit Zone, the keypad will beep for a programmable delay time, notifying you to exit the site
Entrance Chimes	When an Entry Zone or Entry/Exit Zone triggers while armed, the keypad will beep, notifying you to disarm the zone in the programmed delay time.
Siren Output Arm/Disarm Chirps	If enabled, a confirmation Siren Chirp will sound when the RFI is armed or disarmed
Siren Output Pairing Chirps	If enabled, a confirmation Siren Chirp will sound to indicate an RF sensor has paired

5.4 OUTPUTS

The RFI has two configurable outputs. These can be configured to turn On or Off based on the type of alarm or other user defined functionality. See "12.6.23 Relay Functions" on page 44.

5.5 INPUTS

The RFI has two fully configurable inputs. These can be programmed to control the RFI such as Arm/Disarm or act as wired alarm zones.

Each input programmed as a wired alarm zone will reduce the total number of RF sensors that can be paired by one. The wired alarm zones will always be Zone 1 and Zone 2 of the device. Programming only Input 2 to be a wired zone will set this input as Zone 1 of the device.

6 PAIRING SENSORS

Each RF sensor will need to be paired/linked to the RFI. As each sensor is paired, it will be allocated the next available zone number. The RFI can monitor a total of 8 RF and wired sensors. The pairing process is straight forward and can be achieved with the RF sensors already installed.

Care must be taken when pairing large systems using more than one RFI device. An RF sensor will not pair to the same RFI twice, however if this sensor is triggered when a different RFI is in Pairing Mode, this RFI will happily pair to the sensor if it is in range. This means that more than one RFI can pair to the same sensor.

6.1 SINGLE PAIR MODE

Single Pair mode requires the pairing button on the RFI to be pressed for each paired device. This is beneficial when the system is already installed and operating, and there is limited foot traffic around the site.

When pairing RF sensors, this process requires two operators to perform successfully: one person to press the pairing button, the other to trigger the sensor. Alternatively ensure that only one sensor can transmit at a time by turning off all your sensors and then turning them on one at a time to pair them.

To use single pair mode:

1. Turn on the RFI, ensure it is disarmed
2. Press the Pairing button in accordance to the below table:

Button Presses	Armed LED Blinks	Operation
1	Slow flashing	Pair Sensor
2	3 Quick blinks	Pair Roboguard Sensor on Tamper
3	Fast blinks	Pair Remote

Note: There is a 5 second delay between pressing the pairing button and the device being able to be paired. This delay allows you to press the button again without accidentally pairing a device.

3. The Armed LED will flash slowly
4. Once 5 seconds has passed, trigger the sensor
5. If it was successful the Armed LED will turn On for 3 seconds. You can

optionally configure the Siren output to trigger when a sensor pairs. Remote's will not trigger this siren output

6. To pair more devices repeat from step 2

6.2 KEYPAD CODES (PAIRING)

Keypad Code	Function
[Installer PIN]*51#	Pair Sensor
[Installer PIN]*52#	Pair RoboGuard Sensor on Tamper
[Installer PIN]*53#	Pair Remote
[Installer PIN]*55#	Unpair Last Sensor or Remote (4 minute timeout from Pairing)
[Installer PIN]*56#	Erase all RF devices
[Installer PIN]*57#	Erase all RF Sensors
[Installer PIN]*58#	Erase all RF Remotes
[Installer PIN]*71#	Pair RG Button - Arm Function
[Installer PIN]*72#	Pair RG Button - Disarm Function
[Installer PIN]*73#	Pair RG Button - Arm/Disarm Function
[Installer PIN]*74#	Pair RG Button - Arm Home Function (not implemented)
[Installer PIN]*75#	Pair RG Button - Call (Chime) Function
[Installer PIN]*76#	Pair RG Button - Panic Function
[Installer PIN]*77#	Pair RG Button - Toggle Auxiliary Output Function
[Installer PIN]*78#	Pair RG Button - Pulse Output Function

6.3 CONTINUOUS PAIR MODE (ADVANCED)

Continuous mode allows a single installer to pair the 8 zones without having to return to the RFI after pairing each sensor. This requires the installer to trigger the sensors in sequence and is best performed when the site is clear of all people. It is recommended that the Siren output is configured to chirp on a successful pairing to provide feedback to the installer.

Continuous mode is OFF by default. It is enabled via a keypad.

To pair in continuous mode follow these steps:

1. Turn on the RFI, ensure it is disarmed
2. Enable Siren Arm Chirp via a keypad and connect the Siren/Beeper to the output
3. Press the Pairing button in accordance to the below table:

Button Presses	Keypad (Optional)	Operation
1	[Installer PIN]*51#	Pair Sensor
2	[Installer PIN]*52#	Pair Roboguard Sensor on Tamper
3	[Installer PIN]*53#	Pair Remote

4. The Armed LED will flash slowly
5. Once 5 seconds has passed, trigger your first sensor
6. If it was successful the Siren will sound twice
7. To pair more sensors continue to trigger them one at a time. Remember the order you triggered them in as the first 1 will correspond to Zone 1 and so on
8. To exit continuous mode you will need to press the Pairing button twice more. The Armed LED will now be off

NOTE: When pairing RF remotes, the siren will not sound. The Pairing LED is the only indication that a pairing was successful.

6.4 REMOVE LAST PAIRED DEVICE

In some instances you might have accidentally added an incorrect sensor or remote, or one out of sequence. The RFI has the ability to remove this last paired device.

To 'unpair', press and hold the pairing button. After 1/2 a second, the Armed LED will turn On. After another 1/2 second, the Armed LED will start to flash quickly. Remove your finger from the pairing button and the last sensor or remote will be 'unpaired'. A device can only be 'unpaired' if it was paired less than 4 minutes prior.

You can also use the keypad to 'unpair' a device by entering **[Installer PIN]*55#** within the same 4 minute window.

6.5 FACTORY DEFAULT

Returning to Factory Defaults will erase the memory of all paired sensors, remotes and the programming options. This means that all RF devices will need to be paired again.

If you wish to default the device you can follow these steps:

1. Remove power from the RFI
2. Press and hold the Pairing Button
3. Apply power to the RFI

All of the LEDs will turn ON during Power-up, indicating the unit has returned to Factory Defaults

6.5.1 Deleting Sensors, Remote's and Defaulting Programming options

To delete Sensors, Remote's and default the programming options you will need a keypad. Connect the Keypad directly into the RFI, not into the Keypad wiring linking multiple devices

Function	Key Sequence
Erase all RF devices	[Installer PIN] [*] [5] [6] [#]
Erase all RF Sensors	[Installer PIN] [*] [5] [7] [#]
Erase all RF Remote's	[Installer PIN] [*] [5] [8] [#]
Reset and return to factory defaults	[Installer PIN] [*] [6] [8] [#]

7 CONTROLLING YOUR RFI

- Your RFI has been designed for ease of operation. The unit may be armed and disarmed using any of the following:
- A switch connected to an input that is programmed as Arm/Disarm
- A JVA Remote Key Fob
- A RoboGuard Remote button programmed for Arm, Disarm, Arm/Disarm
- Z Series Keypad (4-Line or Touch)
- PC or Smart Phone using Cloud Router™ *Internet and Cloud Gateway Required

Note: More than 1 method may be used in the one installation.

7.1 INPUT CONTROL

The IN1 input (by default) is programmed to arm the RFI when a short is placed across the terminals.

7.2 JVA KEY FOB



The JVA RF Remote key fob has dedicated arm and disarm buttons to ensure you achieve your desired response. The remote will arm/disarm all zones paired with the RFI.

7.3 ROBOGUARD REMOTE



Roboguard remote buttons need to be paired to a specific function. A button can be paired as:

- Arm all zones
- Disarm all zones
- Arm/Disarm all zones. This button will toggle the RFI between Armed and Disarmed states.

7.4 4-LINE KEYPAD



The 4-line keypad has dedicated Arm and Disarm buttons that require a user PIN to operate. This will Arm or Disarm all zones on the site connected to the Keypad.

7.5 TOUCH SCREEN KEYPAD



Individual zones can be armed or disarmed using this intuitive interface. A user PIN is required to first 'log-in' to the keypad.

7.6 CLOUD ROUTER™

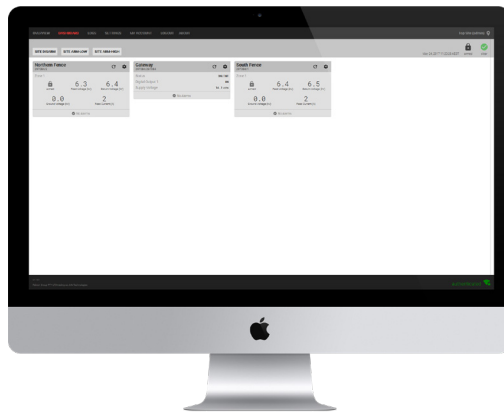

Cloud Router™ allows you to individually control each zone on the site through your internet enabled smart phone or personal computer.

7.7 CONTROL ARBITRATION

If an installation contains two ways to control the RFI, then the most recent control signal will determine the Armed/Disarmed state. For example if the RFI is armed via the keypad and then disarmed at the control input (IN1) it will disarm.

8 WHEN AN ALARM OCCURS

8.1 RFI DEVICE

The Alarm LED will turn on.

If the output relays are configured to Siren and Strobe (default functionality), these will turn On. The siren will cycle on and off based on the programming options, see "12.4 Programming Options" on page 35. The strobe will remain on even after the RFI is disarmed. This will turn off when the RFI is either re-armed, or a User Interface switches it off.

8.1.1 To Silence an Alarm

To silence an alarm, disarm the RFI device using the input switch or remote.

8.1.2 To Clear Alarm Memory

To clear the alarm memory (Strobe), simply re-arm again.

8.2 4-LINE KEYPAD

The red alarm LEDs on the Keypad will turn On. The Keypad beeper will sound if the keypad has Alarm Tones enabled. Press any key on the Keypad to stop the beeper sounding. The keypad will be displaying the zone that is in alarm.

8.2.1 To Silence an Alarm

Enter 1470# to silence any sounding Siren.

This will silence the alarm but not disarm the system. The alarm memory will still be active and will need to be cleared or the siren will sound again after the Siren Off Time has elapsed.

8.2.2 To Clear Alarm Memory

Press *1# on the Keypad, will clear the alarm memory. If the problem still exists or re-occurs, the device will alarm again.

8.3 TOUCH KEYPAD

The Touch Keypad will displays an alert icon whilst the top bar changes to red. The Touch Keypad beeper will sound, press on the screen to silence the beeping sound. The Touch Keypad will be displaying which zone is in alarm.

8.3.1 To Silence an Alarm

To silence a Siren, disarm the device displaying the alarm. The alarm memory will still be active.

8.3.2 To Clear Alarm Memory

To clear the alarms, press on the 'Alarms' button on the front screen. You will see a list of the issues that set it into alarm, fix the issues before proceeding. Now click on the 'Clear Resolved Alarms' button.

8.4 CLOUD ROUTER™

The Cloud Router™ software will display a popup notification on the screen. Optionally, it will send you an Email, SMS and Facebook message. The Dashboard page will display which zone is in alarm.

8.4.1 To Silence an Alarm

To silence an alarm, disarm the RFI device using the Cloud Router™ software.

8.4.2 To Clear Alarm Memory

To clear the alarm memory, either re-arm the device, or click on the  icon on Cloud Router™. Any alarm condition still occurring will trigger the alarm again.

9 RFI INTERFACES

9.1 4-LINE KEYPAD INTERFACE



The RFI can be installed in a convenient location central to the sensors, while a well positioned keypad can become the user interface to the entire system. It will display the status for each zone periodically and will quickly indicate an alarm condition via a beeper and the red alarm LEDs.

The PTE0240 4-Line keypad is a Mid-Range Keypad

- Control, monitor and program any Z-Series device
- Displays arm/disarmed status and any trouble or alarm
- 4-line Backlit Liquid Crystal Display
- Programmable zone names
- Key area glows red on alarm
- Menu driven interface
- Quick arm / disarm keys
- 500-entry Event-Log
- Battery-Backed Real Time Clock
- Event Log stores Date and Time of Alarm or Trouble

9.1.1 RFI Relevant Keypad Codes

The default user pin is 1234. The default installer pin is 012345.

Function	Key Sequence
Arm	
Disarm	
Start Programming the RFI unit	[Installer PIN] [*] [0] [#]
Exit Programming (any mode)	[*] [#]
Pair Sensor	[Installer PIN] [*] [5] [1] [#]
Pair Roboguard Sensor on Tamper	[Installer PIN] [*] [5] [2] [#]
Pair Remote	[Installer PIN] [*] [5] [3] [#]

Function	Key Sequence
'Unpair' last sensor or remote (4 minute time out from Pairing)	[Installer PIN] [*] [5] [5] [#]
Erase all RF devices	[Installer PIN] [*] [5] [6] [#]
Erase all RF Sensors	[Installer PIN] [*] [5] [7] [#]
Erase all RF Remote's	[Installer PIN] [*] [5] [8] [#]
Arm Function	[Installer PIN] [*] [7] [1] [#]
Disarm Function	[Installer PIN] [*] [7] [2] [#]
Arm/Disarm Function	[Installer PIN] [*] [7] [3] [#]
Arm Home function (not implemented)	[Installer PIN] [*] [7] [4] [#]

For more information refer to section "13.1 PTE0240 4-Line Keypad" on page 48

9.2 TOUCH KEYPAD INTERFACE

JVA's most advanced keypad features include:

- Touch screen with clean user interface designed for ease of use
- Quickly arm or disarm the entire site gradually via the Zones screen
- Emails on alarm
- View all active and latched alarms in the alarms screen
- Program all Z-Series devices through an intuitive system, without having to remember or refer to a manual for key sequences. With the new MK2 protocol, these devices can be all programmed together without having to isolate each device individually
- The ability to monitor and log all user actions
- Large detailed event log

Refer to the in built help tool in the Touch Keypad.

9.3 CLOUD ROUTER™ INTERFACE

The Cloud Router™ provides control and monitoring for your security system. Security devices are linked to the Cloud Router™ Software via Nimbus Gateways. GSM, LAN and Wi-Fi Gateways are available for purchase.

Administrators "claim" their Gateways using a unique code and from there gather the attached devices into a "site". Devices attached to the Gateway can then be monitored and controlled.

For more information about Cloud Router™ see this link: www.jva-fence.com/cloudrouter

10 INSTALLATION

It is recommended that all installations are performed by qualified technicians.

10.1 INSTALLATION STEPS

1. Read the entire RFI manual first!
2. Position the RF Sensors according to your security requirements
3. Decide where the RFI and Keypad are to be mounted. If on an external wall it should be housed within a weatherproof equipment box, shaded from direct sun.
4. Remove the RFI PCB chassis from the housing by depressing the top mounting clip and tilting the PCB towards yourself.
5. Mount the housing by using 2 screws through the rear of the box. The box must be mounted to a wall in such a way that both holes in the rear of the case are against the mounting surface.
6. Replace the PCB chassis.
7. If using a keypad, mount two screws to the wall and slide the back of the keypad over them so that it is flush with the wall.
8. Wire the keypad and RFI together as well as any other Z-series device if needed
9. Fit the input (+12 GND) power leads to the power source.
10. Turn the power source on.
11. Pair up to 4 Remote's. Refer to "6 Pairing Sensors" on page 16
12. Pair up to 8 Sensors. Refer to "6 Pairing Sensors" on page 16
13. Walk test the system, checking that each of the sensors is detected by the RFI and/or User Interface.
14. Perform a siren test
15. Arm your system and check the exit and entry delays work
16. Create an alarm and check that the siren operates and that the User Interface reports the alarm correctly.

11 WIRING DIAGRAMS

11.1 KEYPAD BUS WIRING

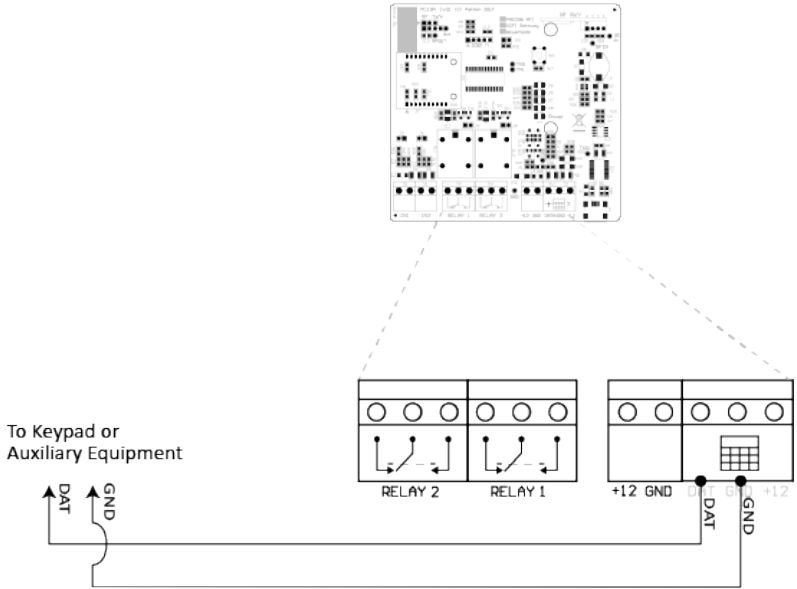

11.2 INPUT WIRING EXAMPLE

11.2.1 Dry Contact

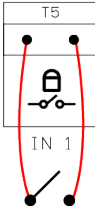

11.2.3 Pull Up to +5V

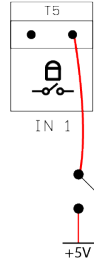

11.2.2 Pull Down To Ground

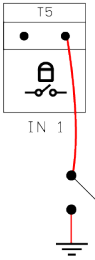

11.2.4 Pull Up to +12V

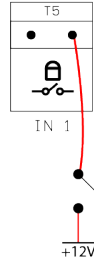

11.3 OUTPUT WIRING EXAMPLE

11.3.1 Off State

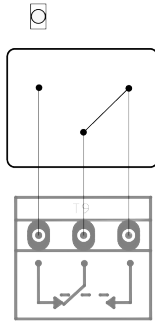

11.3.3 Alarm State

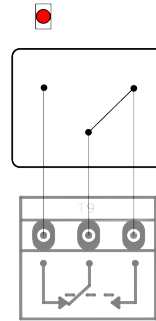

11.3.2 On State

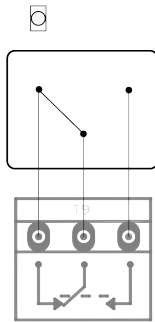

11.3.4 12V To Common

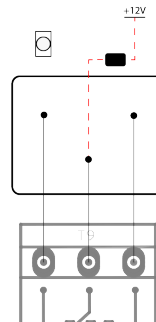

12 TECHNICAL INFORMATION

12.1 CONTROL, POWER AND IO TERMINALS

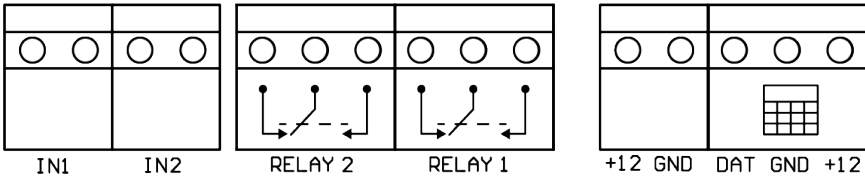

Label	Type	Description
IN1	2 way	Control input 1 (dry contact momentary) internally wired in parallel with the key switch. Can be used for a remote switch or a radio receiver. The receiver may be powered from the keypad +12V terminal.
IN2	2 way	As above.
Relay 1	3 way	Switched 12V output. 30W max. A buffer relay should be used when connecting these outputs to an alarm panel. Low side switched
Relay 2	3 way	Switched 12V output. 30W max. A buffer relay should be used when connecting these outputs to an alarm panel. Low side switched
Power	2 way	12V DC connection, used to power the unit.
Keypad (DAT GND +12)	3 way	Supplies power and data line for an external keypad. The +12 source on these terminals is protected with 1A self resetting fuse.

12.2 STATUS LED (D8) ERROR MESSAGES

The status LED (D8) indicates error codes for easy diagnostics while installing the system.

Flashes	Issue	Description
1	Tamper	<ul style="list-style-type: none"> Triggered an Input set up as a tamper Tamper signal from a non bypassed RF sensor
2	AC Fail	not used.
3	Low Battery	From any Non Bypassed RF sensor
4	Error	<ul style="list-style-type: none"> Memory (on startup); Communication failure on Keypad bus Communication failure on any active RF sensor

12.3 JUMPERS

Jumper	Function	Purpose
J3 & J5	Enable dry contact J3: IN1 J5: IN2	Fitting a jumper will enable dry contact to be used
J6 & J8	Supply +12V to Relay Common. J6: Relay 1 J8: Relay 2	Fitting a jumper will supply +12V to the specific relay common. NOTE: This is a low current system, it cannot supply more than 20mA per relay.

Jumper	Function	Purpose
J10	SOMETHING	SOMETHING

12.3.1 How to fit a Jumper

A fitted Jumper is shown as closed in the diagram below. If a jumper is not to be fitted it can be placed over a single pin, this is shown as open in the diagram below.

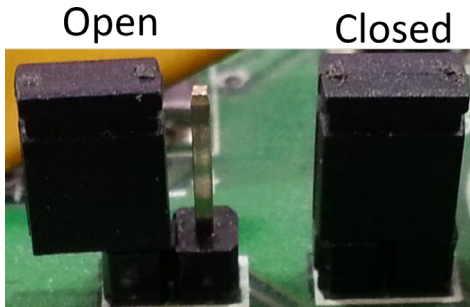

13

PROGRAMMING OPTIONS

The RFI has non-volatile memory in which programming options (or setup parameters) can be stored. These are factory pre-set (defaults), but can be field programmed using a keypad.

NOTE: The default installer PIN is 012345.

13.3.1 Programmable Options Table

Option	Function	Default	Description
01	Group ID	1	If used as part of a group, this sets the device ID
02	Zone 1 type	0	Sets the type of Zone
03	Zone 2 type	0	As Above
04	Zone 3 type	0	As Above
05	Zone 4 type	0	As Above
06	Zone 5 type	0	As Above
07	Zone 6 type	0	As Above
08	Zone 7 type	0	As Above
09	Zone 8 type	0	As Above
10	Input 1 Hardware	0	Sets the type of Input Hardware
11	Input 1 Function	8	Sets the function of the Input
12	Input 2 Hardware	1	Sets the type of Input Hardware
13	Input 2 Function	7	Sets the function of the Input
14	Supply Voltage Level	110	90-135 (9.0V – 13.5V) The voltage set point for the power supply below which a Supply Fail event is triggered
15	Entry Delay	30	0-240 seconds of Entry/Gate Delay
16	Exit Delay	30	0-240 seconds of Exit Delay
17	Gate Delay	60	0-240 seconds before the Gate Alarm triggers
18	Siren On Time	4	Sets the time that the siren will stay on after an alarm

Option	Function	Default	Description
19	Siren Off Time	4	The amount of time the siren will be off after the on time has expired
20	Siren Cycles	3	The number of times the siren will sound for the time set in on time above. After this many cycles the siren will automatically mute
21	RF coms fail (minutes)	20	1-240 minutes. An RF zone is considered in coms fail if it does not report in under this time. Only applied to RF sensors that send a ping on a regular basis (Roboguard Beams)
22	RF coms fail (days)	7	1-30 days. An RF zone is considered in coms fail if it does not report in under this time while disarmed. Walk test the sensor to reset the coms fail
23	Auto Rearm Time	0	Sets the time which must elapse after an alarm has timed out (completed the siren cycles) before the unit will automatically re-arm ready for the next alarm event
24	Relay 1	8	Used to assign an alarm function to relay 1 (siren output)
25	Relay 2	9	Used to assign an alarm function to relay 2 (strobe output)
26	Anti-Jamming	12	Sets the time in seconds to determine that the RF Interface is being Jammed with RF signal.
27	Binary Options	0	Configurable options, enabled or disabled
28	Pulsed Output Duration	20	0.1-24.0 seconds. A Relay can be set to a pulsed output, this option will set the duration that the pulse is On

13.1 PROGRAMMING OPTIONS IN DETAIL

13.2 Group Id

A group must have only 1 master set to ID 1. The other Z-series devices in the group must have unique values between 2 and 15. If two devices have the same ID value, this will cause alarm reporting problems.

Default value is 1

The correct procedure is:

Connect the keypad to each Z-series device in turn, enter programming mode and set the Group ID, exit programming mode. Now link the Keypad bus into a group and use the Menu Driven programming system to change settings on individual devices.

13.2.1 Zone 1 - 8 Alarm Type

This option allows each zone on the RFI to be configured for different alarm types. **Default Alarm Type is Instant Alarm**

Alarm Type	Description
Instant Alarm	Immediate alarm triggering on detection when armed
Home	When the RFI is "Armed while Home", the zones configured as Home will remain disarmed
Entry Route	Zones configured as Entry will trigger an alarm if the Entry Delay elapses and the RFI is not disarmed. This allows someone to enter the site through a dedicated path and access a keypad to disarm without triggering an alarm
Exit Route	Zones configured as Exit are "bypassed" for the Exit Delay after the RFI is armed. This allows someone to arm and then exit the site through a dedicated path
Entry and Exit Route	These zones are a combined entry and exit system
Wired	This is a Wired Zone either Input 1 or Input 2. The zone functionality is configured in the Input Function option

Alarm Type	Description
Chime	When disarmed this zone will send the Chime signal to all Keypads or "Chime Outputs" to indicate the zone has activated

13.2.2 Input 1 and 2 Hardware Type

Input 1 and Input 2 can be configured to use different activation signals.

Input 1 defaults to Normally Open - Arm

Input 2 defaults to Normally Closed - Tamper

Hardware Type	Description
N/O - Normally Open	The Input function will 'activate' when the input is shorted
N/C - Normally Closed	The Input function will 'activate' when the input is opened
Tag - Momentary Signal	The Input function will 'activate' with a pulsed signal

13.2.3 Input Function

Input 1 defaults to Normally Open - Arm

Input 2 defaults to Normally Closed - Tamper

Input Function	Description
Instant Alarm	Immediate zone alarm when activated
3 second Alarm	Requires 3 seconds of continuous activation before a zone alarm occurs
Entry Route	After activation, a zone alarm will occur if the Entry Delay elapses and the RFI is not disarmed
Exit Route	This zone is "bypassed" for the Exit Delay after the RFI is armed
Entry / Exit Route	A combination of Entry and Exit Route
Chime	When disarmed, this zone will trigger a Chime signal
Gate	If the input remains open for the Gate Delay, the "Gate Alarm" will trigger

Input Function	Description
Tamper	If this input activates, it will immediately trigger the "Tamper Alarm"
Arm RFI	Activating this input will Arm this RFI
Arm Group	Activating this input will Arm all devices in the Group (not implemented at present - future improvement)
Pass Through	This input has no interaction with the RFI, the input state is passed to a User Interface to process

13.2.4 Low Power Supply Level

A DC Fail, Supply Fail Alarm will be triggered when the supply voltage falls below this set-point. The default value is 11.0V

The alarm will clear when the supply has increased 1.0V above the Low Power Supply Level.

13.2.5 Entry Delay

Specify a Entry/Gate Delay in seconds. Ranging from 0 to 255

13.2.6 Exit Delay (16xxx#)

Specify an Exit Delay in seconds. Ranging from 0 to 255

Value (xxx)	Function
0	Instant
1	1 Seconds
...	...
30	30 Seconds
...	...
254	254 Seconds
255	255 Seconds

13.2.7 Gate Delay (17xxx#)

Specify an Exit Delay in seconds. Ranging from 0 to 255 Seconds

Value (xxx)	Function
0	Instant
1	1 Seconds
...	...
60	60 Seconds
...	...
254	254 Seconds
255	255 Seconds

13.2.8 Siren on Time (18x#)

This option sets the duration of time that the siren will remain on after a fence alarm occurs. After this time the siren will turn off for the Siren Off Time indicated in the table. The siren will sound again if the alarm is still present after this off time has passed.

The default is 3 Minutes. This may be the subject of local regulations to stop an alarm causing undue disturbance to neighbours, etc.

Note: the siren on time will be cut short if the battery falls below the low battery level.

Value (x)	Function
0	10 Seconds
1	30 Seconds
2	1 Minute
3	2 Minutes
4	3 Minutes
5	4 Minutes
6	5 Minutes
7	20 Minutes
8	45 Minutes
9	130 Minutes

13.2.9 Siren off Time (19x#)

This option sets the amount of time the siren will be off for after the Siren On Time has expired. If an alarm is still present after this off time the siren will sound again.

Value (x)	Function
0	10 Seconds
1	1 Minute
2	2 Minute
3	5 Minutes
4	10 Minutes
5	20 Minutes
6	30 Minutes
7	40 Minutes
8	50 Minutes
9	60 Minutes

13.2.10 Siren Cycles (20x#)

This option sets the maximum number of times the siren will sound for the “on time” if the alarm continues. This may be limited by local regulations to stop an alarm causing undue disturbance to neighbours etc.

Note: This is the maximum number of cycles for 1 continuous alarm, intermittent alarm events could cause more than this number of siren soundings.

Value (x)	Cycles
0	1
1	1
2	2
3	3
4	4
5	5
6	6
7	7

Value (x)	Cycles
8	8
9	9

13.2.11 Zone Communication Fail Time (21xxx#)

A sensor zone is considered in coms fail if it does not report in under this time. The coms fail will only be indicated when the RFI is disarmed. Users will be asked to walk test the sensor. Default value is set to 20 minutes. Ranging from 1 - 255 minutes.

Value (x)	Function
0	Instant
1	1 Minute
...	...
20	20 Minutes
...	...
254	254 Minutes
255	255 Minutes

13.2.12 Zone Communication Fail Time - Long (22xxx#)

A sensor zone is considered in coms fail if it does not report in under this time. The coms fail will only be indicated when the RFI is disarmed. Users will be asked to walk test the sensor. Default value is set to 7 hours. Ranging from 1 - 255 Hours.

Value (xxx)	Function
0	Instant
1	1 Hours
...	...
7	7 Hours
...	...
254	254 Hours
255	255 Hours

13.2.13 Auto Re-Arm Time (23x#)

This option sets the time which must elapse before another alarm will sound after the first alarm has timed out (gone completely through its cycles).

If an event occurs which triggers an alarm, any other events which would otherwise trigger the alarm will be ignored while the alarm is sounding and until after the Auto re-arm time has passed.

A setting of 9 will disable auto re-arm.

The default is 0 Seconds (Immediate).

Value (x)	Function
0	0 Seconds (Immediate)
1	30 Seconds
2	1 Minutes
3	2 Minutes
4	3 Minutes
5	4 Minutes
6	5 Minutes
7	6 Minutes
8	7 Minutes
9	Disabled – Do not auto rearm

13.2.14 Relay Functions

All relays can be set to any of the available functions (user assignable).

Relay 1 is (24xx#)

Relay 2 is (25xx#) etc

Defaults for the RFI

- Relay 1 – Siren (Default: 4)
- Relay 2 – Strobe (Default: 5)

Value (xx)	Mode	
0	Any Zone in Alarm	Turns On when one RF Zone is in Alarm. Turns Off when no alarm is detected and if all RF Zones are disarmed.
1	Any Zone in Alarm or Disarmed	Turns On when one RF Zone is in Alarm or if any RF Zones are disarmed. Turns Off when no alarm is detected.
2	All Zones Armed	Turns On when all RF Zones are armed. Turns Off when at least one RF zone is disarmed.
3	General	Any problem with the RFI (error), or any alarm, or any trouble such as low power source
4	Siren	Turns On with any Zone alarm if Armed. The siren will sound for the length of time as set in the options and for the number of cycles set. If auto-rearm is set the siren will sound again on a new alarm.
5	Strobe	As per Siren but does not time out and will remain on after disarm. Latched.
6	Chime	Specific chime
7	Low Power Source	Triggers when the power source is below the low power threshold
8	Tamper	Triggers when an RF or Wire zone is in tamper alarm
9	Gate	Triggers when a wired sensor is set up as a gate and goes into alarm
10	Panic Mode	Triggers when panic mode is enabled.
11	Input 1 Alarm	If Input 1 is being used as a wired sensor, this will be set to toggle when it is in alarm

Value (xx)	Mode	
12	Input 2 Alarm	If Input 2 is being used as a wired sensor, this will be set to toggle when it is in alarm
13	Host Control	This Relay is completely controlled from a Host system such as Perimeter Patrol or a Keypad. If the Host system is disconnected from the unit for more than 30 seconds, the Relay will automatically change to the Alarm State
14	Host Control - Not Fail Safe	This Relay is completely controlled from a Host system such as a Keypad. If the Host system is disconnected then the Relay will maintain its current state until the Host re-connects and requests the relay to change state.
15	Host Pulse	
16	Auxiliary Toggle	
17	Pulsed Output	Enables the Relay to be a pulsed output. When triggered it will turn On for a certain duration and then turn Off. The duration is set in option 28.

13.2.15 Anti-Jamming (26xxx#)

This is option is set to xxxxxxx

Value (xxx)	Function
0	0 Seconds
1	1 Seconds
...	...
12	12 Seconds
...	...
254	254 Seconds

Value (xxx)	Function
255	255 Seconds

13.2.16 Binary Options (27x#)

Value (x)	Function
0	Enable Siren Chirp on arming attempt
1	Enable Siren Chirp on successful arming
2	Enable Siren Chirp on successful pairing
3	Enable Continuous Pairing Mode
4	Enable Siren Chime
5	Enable Chime on entry
6	Enable Chime on exit
7	Enable panic alarms

13.2.17 Pulse Output Duration (28xxx#)

One Relay can be set to a pulsed output. This option will set the duration that the pulsed output is ON for.

Default value is set to 2 seconds.

The minimum is 0 seconds and the maximum is 25.5 seconds.

Value (xxx)	Function
0	Instant
1	0.1 Seconds
...	...
20	2.0 Seconds
...	...
254	25.4 Seconds
255	25.5 Seconds

14 Z-SERIES KEYPADS

There is currently 1 keypad that can connect to the keypad bus of a RFI device:

- PTE0240 4-Line keypad

This device can be used to control, program and monitor the devices on your fence.



14.1 PTE0240 4-LINE KEYPAD

The JVA 4-Line LCD Keypad is an integral component in the JVA Security Electric Fence product range. Providing a centralised interface between the Customer and their Perimeter Security Solution; it displays the current condition of each security device connected and can draw attention to adverse fence conditions. The keypad is used to control individual fence Energizers, Monitors, RFI's or the entire site. The Customer has access to all of these features via a Menu Driven system or by entering key sequences. Security Installers also use the keypad to configure the JVA Security devices to the customer's needs.

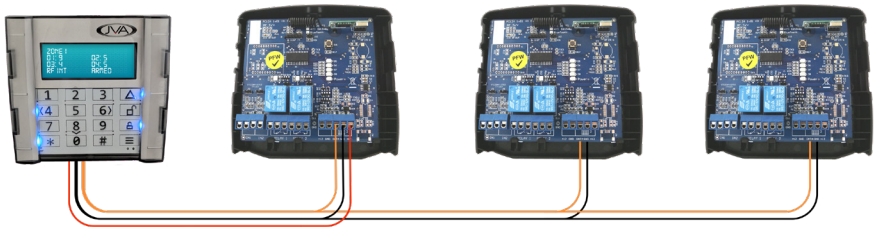
14.1.1 Wiring the Keypad



14.1.2 Arming/Disarming Using the Keypad

Button	Function
	Site Arm. Press this followed by your user PIN to arm the site
	Site Disarm. Press this followed by your user PIN to disarm the site

Button	Function
	Menu. Press this followed by your user/installer PIN to access the keypad menu
1470#	If a Siren is sounding, enter 1470# to mute the siren.

14.1.3 Display screens

In normal operation the keypad shows a Summary Page followed by the status of each device connected to the Keypad.

Since there can be many things to display, the keypad automatically “scrolls” through all relevant information. Each screen is shown for approximately 5 seconds. You can pause the auto scrolling for 20 seconds by pressing the # key. Pressing the # key again will advance the display one screen.

If a new alarm or trouble (low battery etc) occurs, the keypad display will jump to the relevant zone, the keypad will beep (unless toggled off) and auto scrolling will cease for approximately 3 minutes.



Summary Screen

Number	Description
1	The Installer’s Details (Dealer Message)
2	4hr Clock, Date
3	Site is Armed/Part Armed or Disarmed
4	If the site is in Alarm/Trouble or All OK

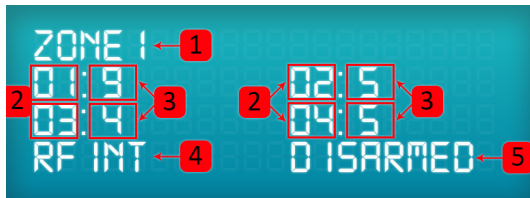

RF Zones Screen

Number	Description
1	Zone 1 refers to group ID 1. In this case the RFI.
2	The RFI Zones from 1 to 8. If zones 5 to 8 are connected the screen will 'scroll' to those zones as well.
3	Signal Strength. 0 is bad signal and 5 is the best signal.
4	The Device Type
5	Site Status. Either Disarmed, Partially Armed or Armed

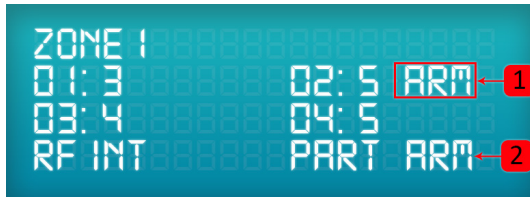

Partially Armed Screen

Number	Description
1	If individual zones are armed it will display 'Arm' next to there signal strength
2	Displays if it is partially armed

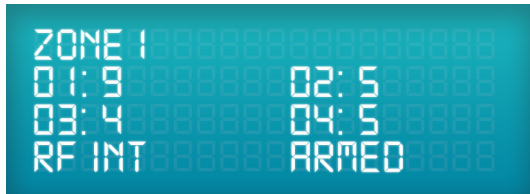

RFI Armed Screen



RFI In Gate Alarm

This screen will be hidden until an alarm occurs. The alarm type will be displayed, the alarms are as follows: Gate, Tamper, DC Fail and Battery.



RFI In Tamper Alarm



RFI In DC Fail Alarm



RFI In Battery Fail Alarm

14.1.4 Menus

The Main Menu contains the following list of entries. Use the Up and Down keys to scroll through the Menu until the Arrow is aligned with the required menu option. Pressing the # key will perform the menu function.

Menu	Function (when # key is pressed)
Mute Siren	Mutes the Device's Sirens currently sounding

Menu	Function (when # key is pressed)
Clear Alarms	Sends the Clear Alarm Memory command to the connected devices
Show Event Log	Displays the Event Log. Use Up/Down keys to scan through events. The # key will exit the Log
Arm Low Power	Arm the Site in Low Power Mode
Arm High System	Arm the Site in High Power Mode
Test Menu	See “5.4 Test Menu” on page <?>
Keypad options	See “5.5 Keypad Options” on page <?>
Set Clock	See “5.6 Setting the Clock” on page <?>
Show Shortcuts	Displays commonly used Key Sequences for reference
Remember User PIN	Saves the PIN so that the Menu, Arm and Disarm buttons will not ask for a PIN
Exit	Exits the Keypad Menu
Menu	The following Menu items are only visible when the Installer PIN is used to access the Menu
Program Device	See “5.8 Program Device” on page <?>
Program Sectors	For Sectorizing ZM20/ZM50
Clear Event Log	Remove all entries in the Event Log
Program this Keypad	Used to change Zone Labels and Keypad ID. See “5.9 Program this Keypad” on page <?>
Default User PIN	This will return the User PIN of connected devices to the default 1234.
Default Keypad	Factory Default this Keypad
Calibrate Device	Allows on-site calibration of Energizers

For more information on the keypad, refer to: www.jva-fence.com/4line

DEALER

